

# INSTRUCCIONES DE INSTALACION

Bosen Industrial [www.bosen.cl](http://www.bosen.cl)

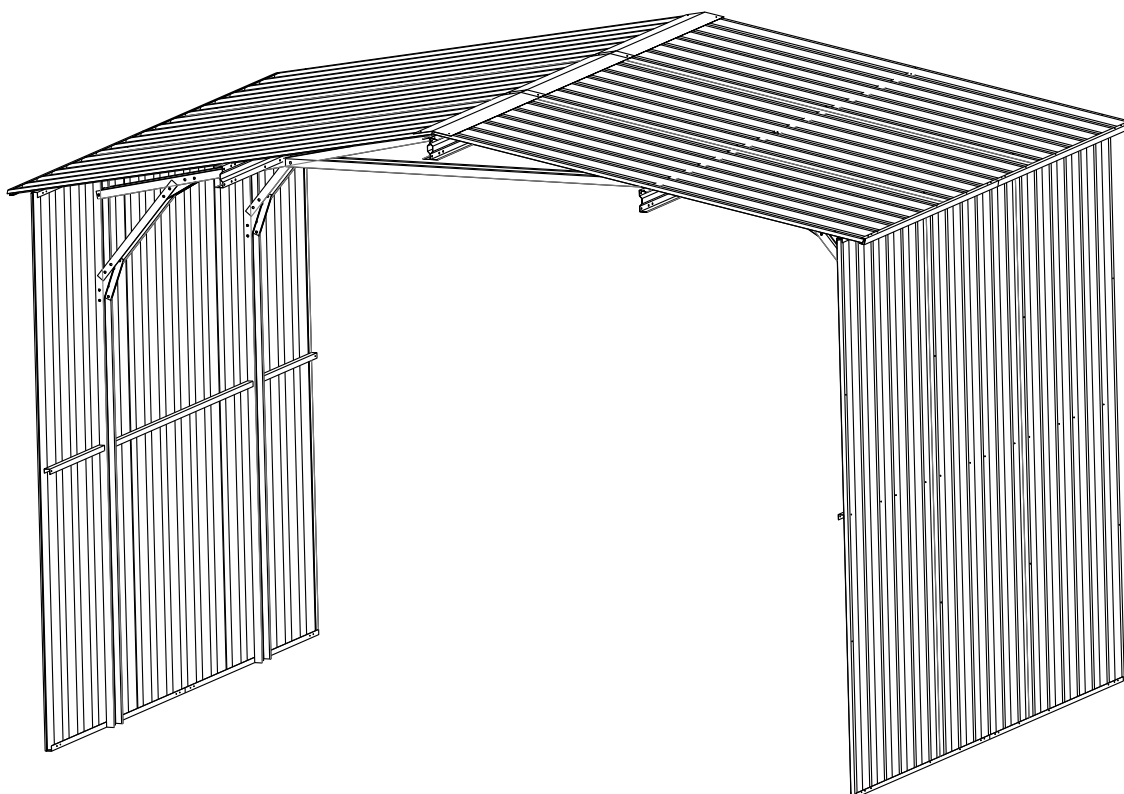





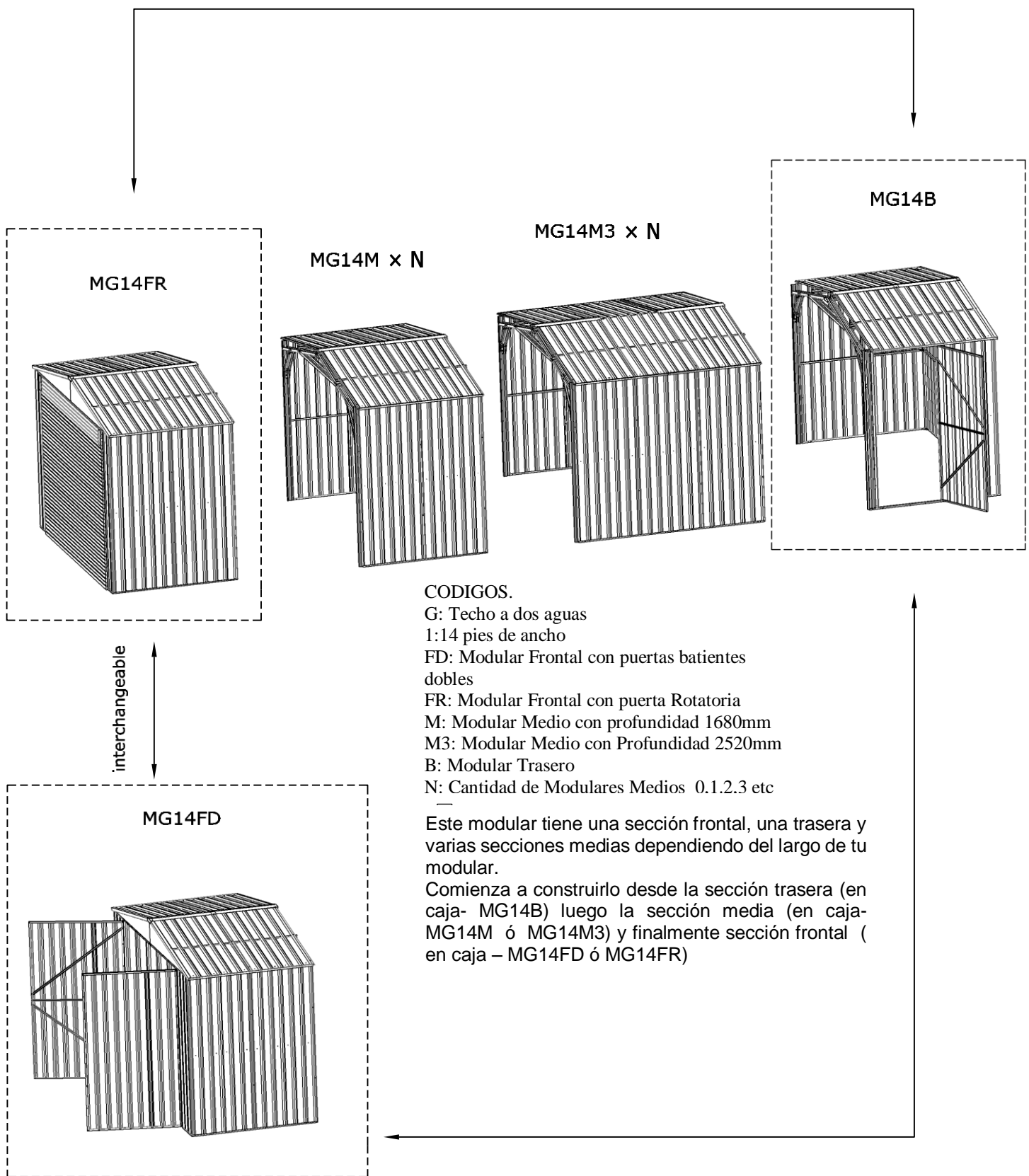

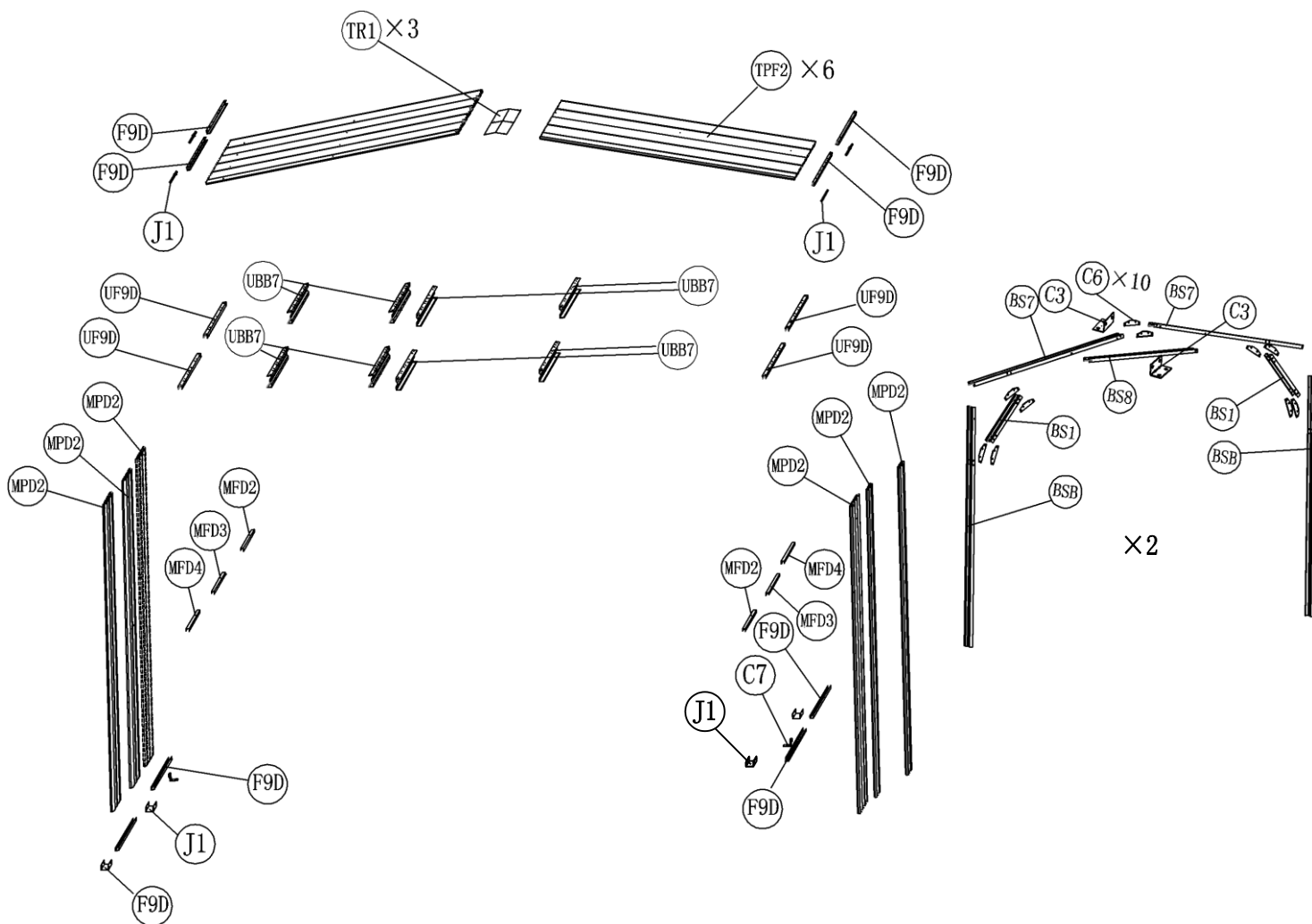
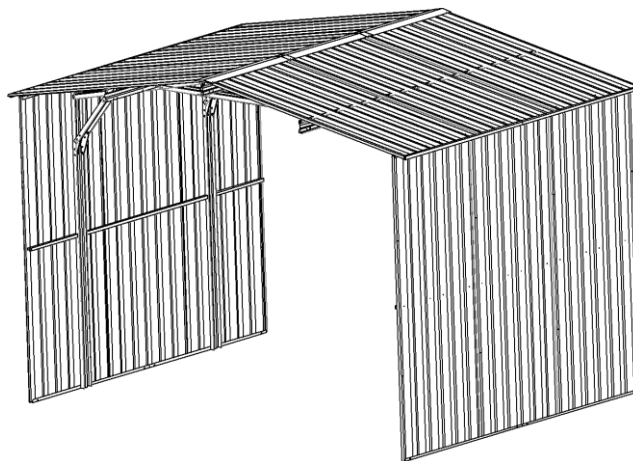

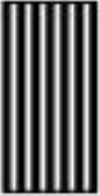















CASA MODULAR – MG14M3



# COMO DEBE SER UNIDO EL MODULAR











IMÁGEN	N° PARTE	CANT	Check	IMÁGEN	N° PARTE	CANT	Check
	MPD2	6			TPF2	6	
	UBB7	8			BSB	4	
	BS7	4			BS1	4	
	BS8	2			TR1	3	
	F9D	8			UF9D	4	
	MFD2	2			MFD3	2	
	MFD4	2			C2	8	
	C3	4			C7	4	
	S11	8			S10	96	
	S5	92			S3	198	
	L3	26			S8	34	
	C6	20			J1	12	
	J2	2			C8	4	

# ENSAMBLAJE DEL MODULAR

## ENSAMBLAJE PARED

	MPD2	3			2
	UF9D	2			4
	J1	2			4

×2

×2

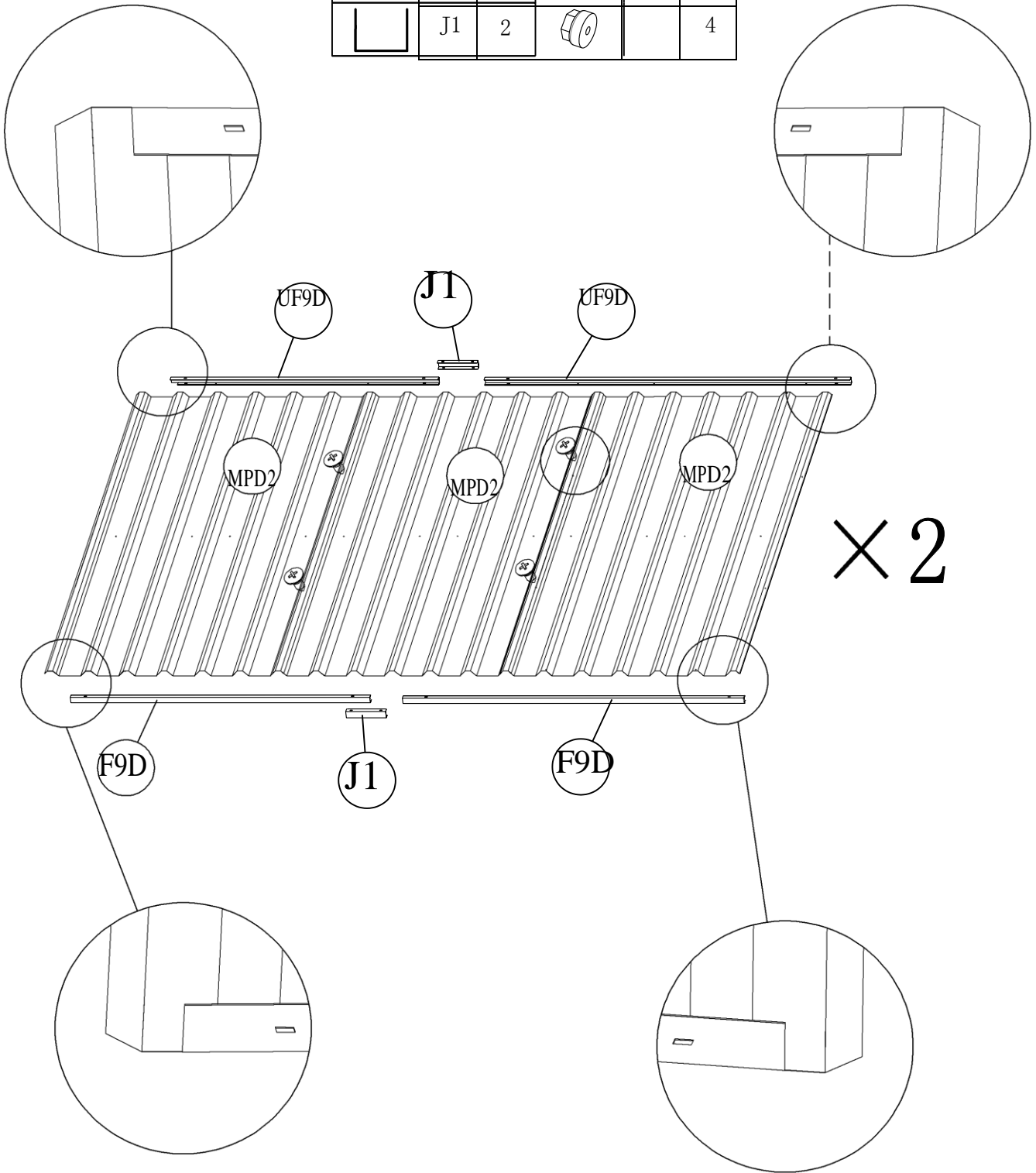

# ENSAMBLAJE DEL SOPORTE

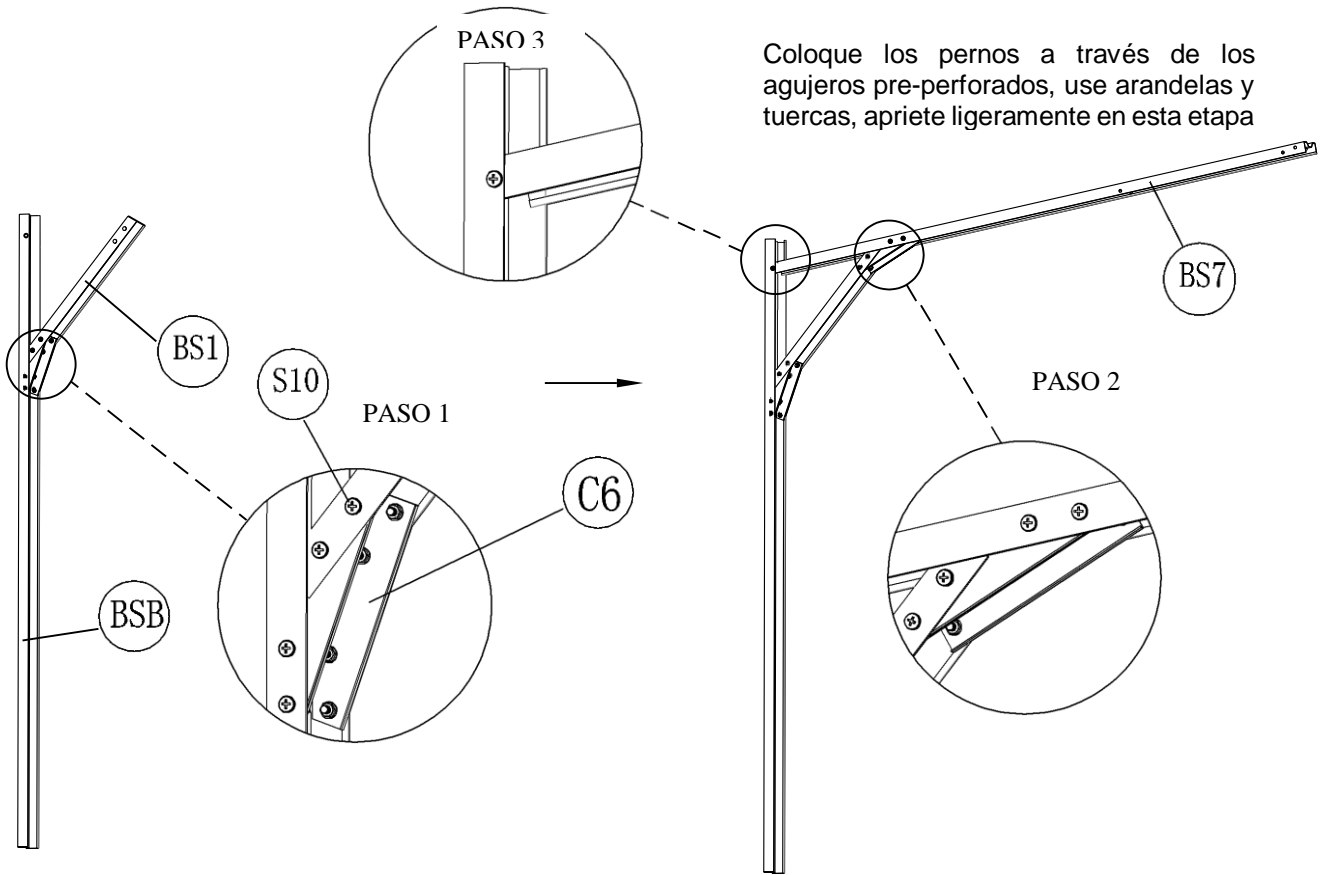

PASO 5 Repita el proceso de ensamblaje del lado izquierdo, para el lado derecho, usando las partes como se muestra en el diseño

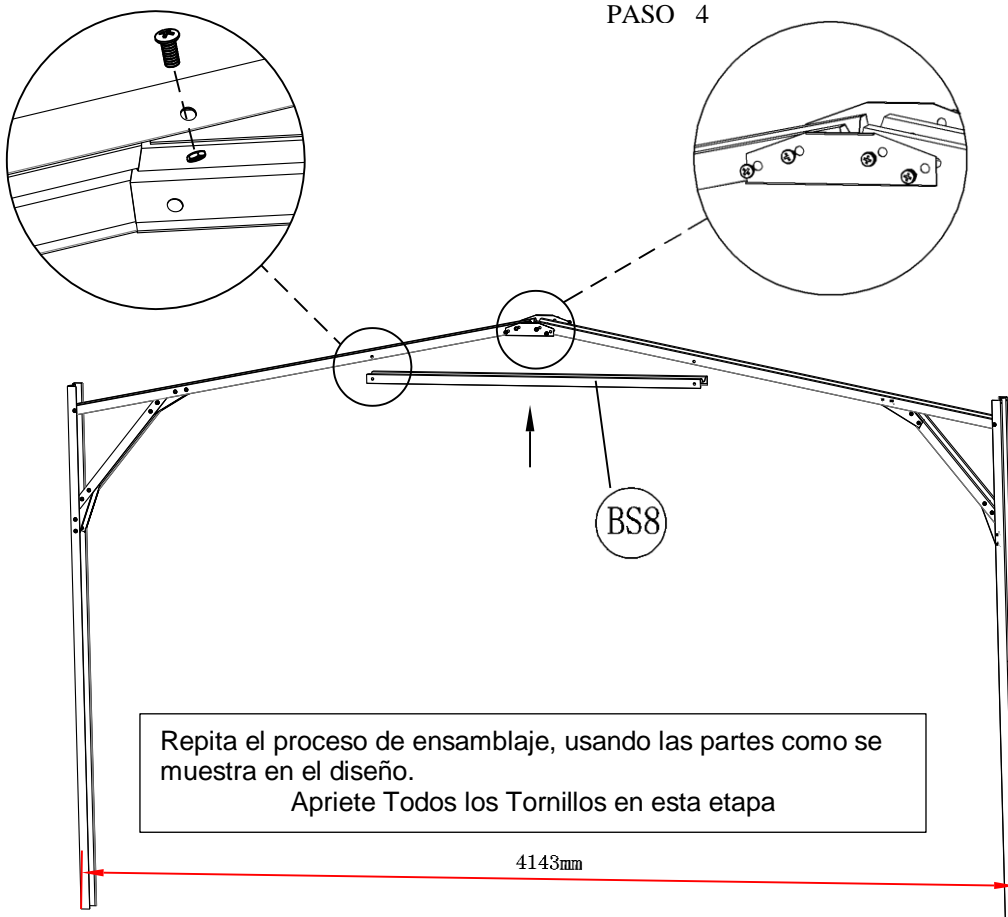

	BSB	2
	BS1	2
	BS7	2
	BS8	1
	S10	48
	C6	10

×2

×2

# ENSAMBLAJE DEL MODULAR

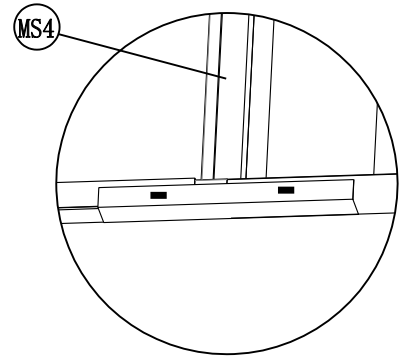
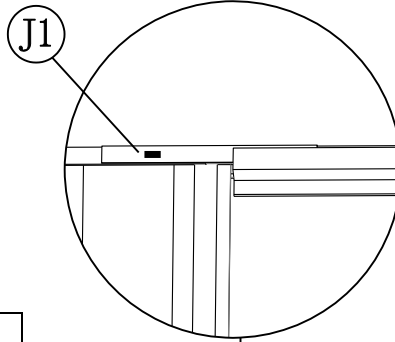
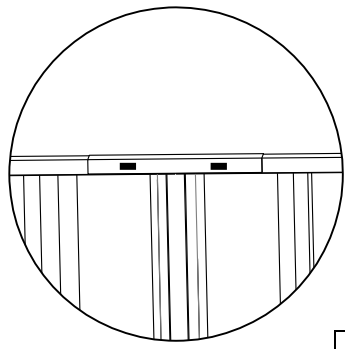

	J1	3
	S3	2
	L3	2

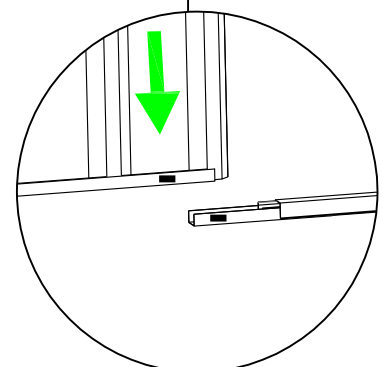
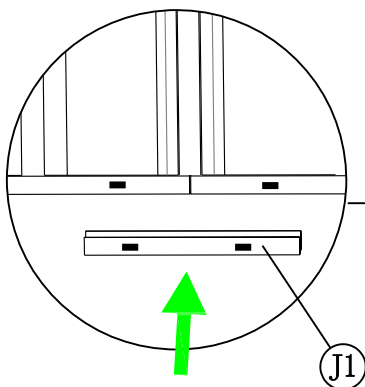
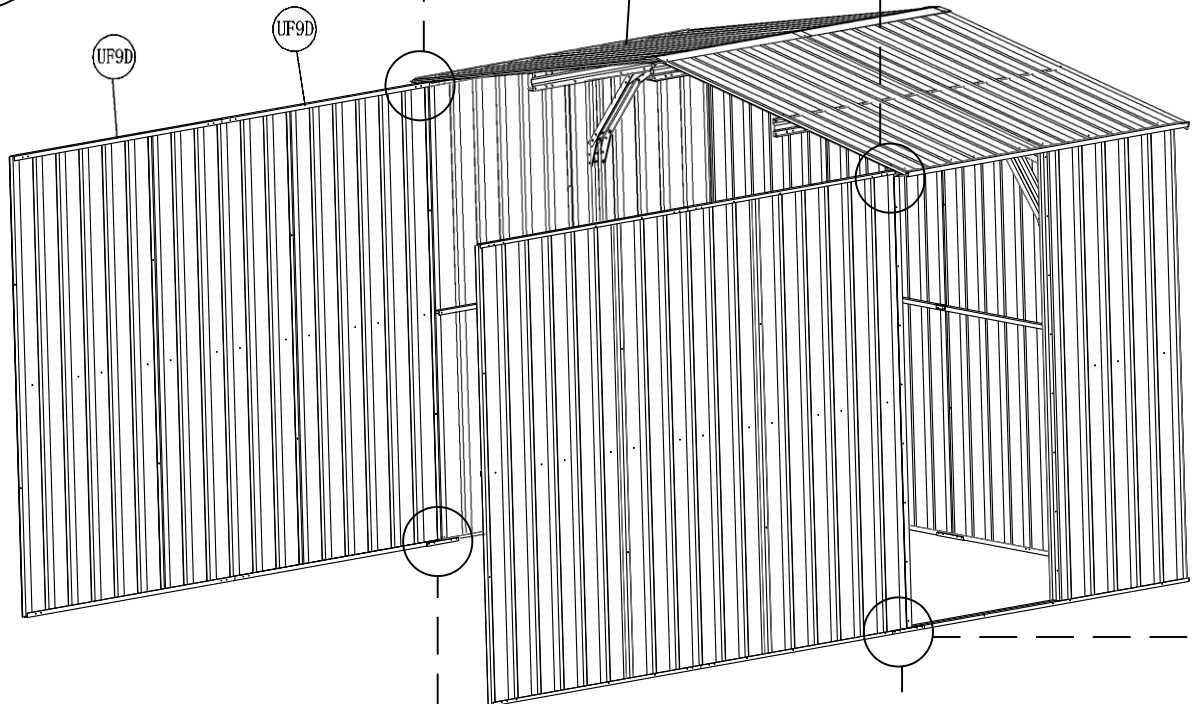
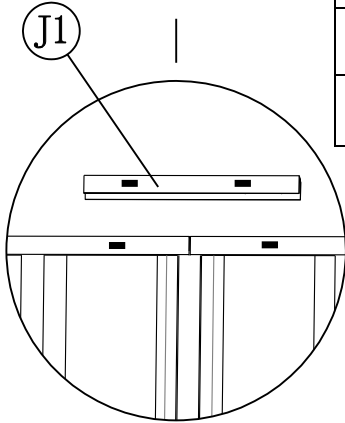

# ENSAMBLAJE DEL MODULAR

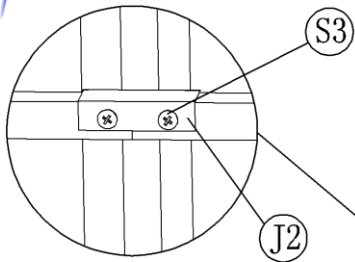

	MFD4	1		J2	1
	S3	8		MFD2	1

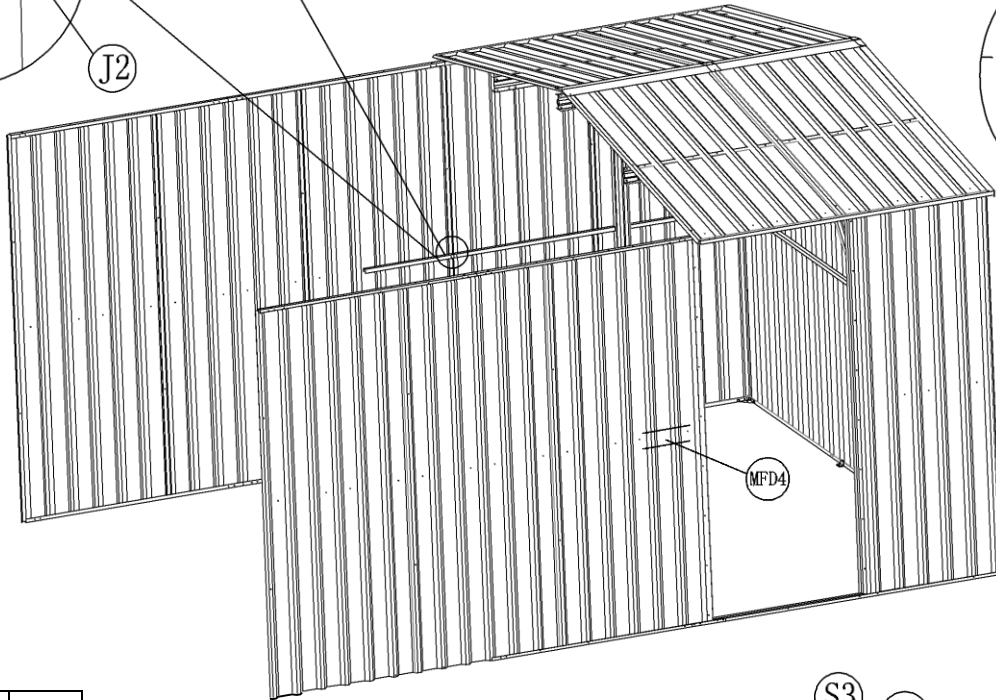
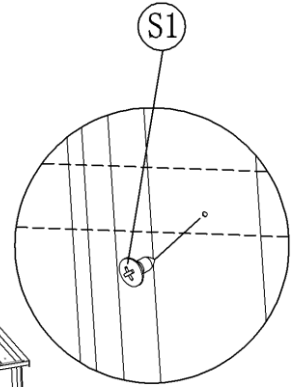

	MFD3	2
	C2	4
	S3	40
	L3	8
	C8	2

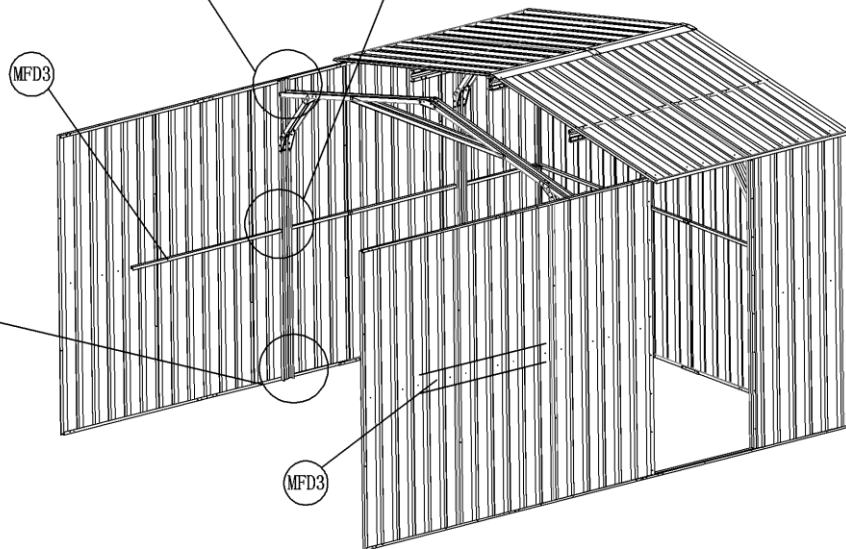
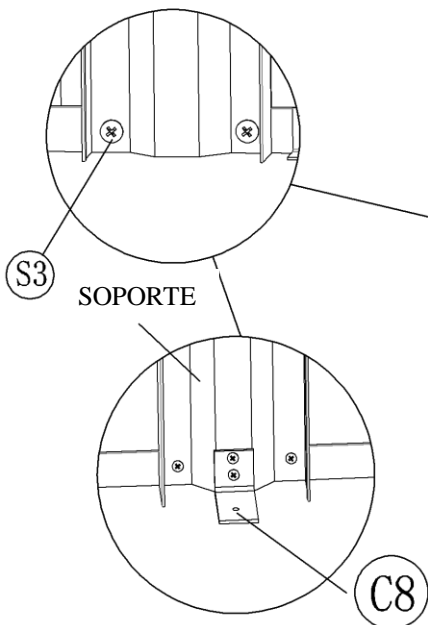
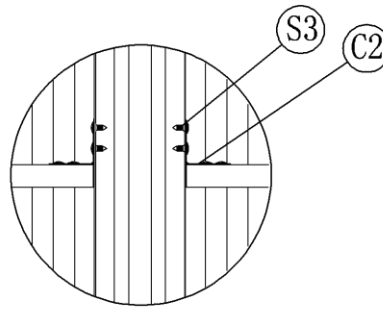
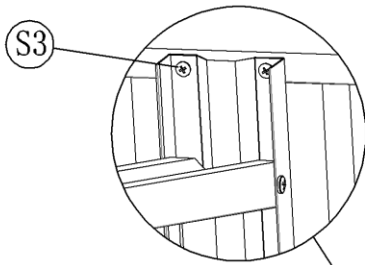



# ENSAMBLAJE DEL MODULAR

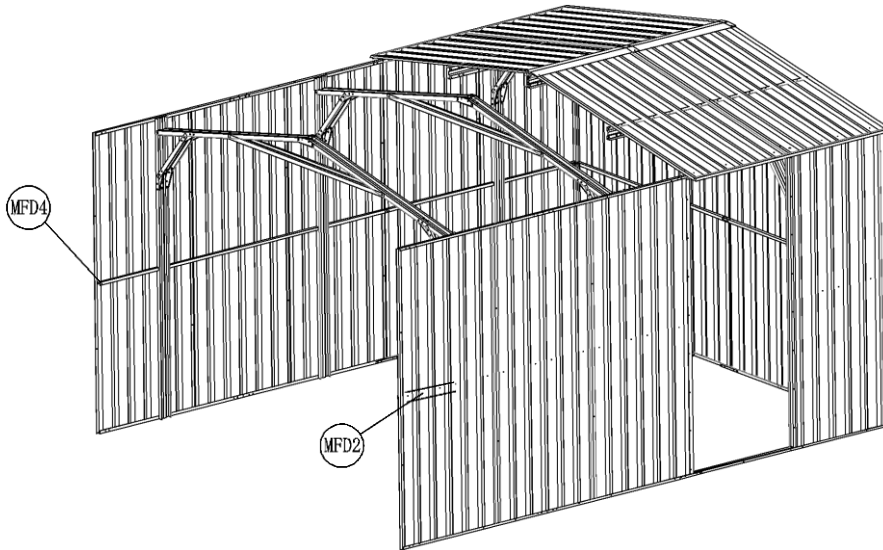

	MFD2	1
	MFD4	1
	S3	34
	C8	2
	C2	4
	L3	8

	UBB7	4		S8	12
--	------	---	--	----	----

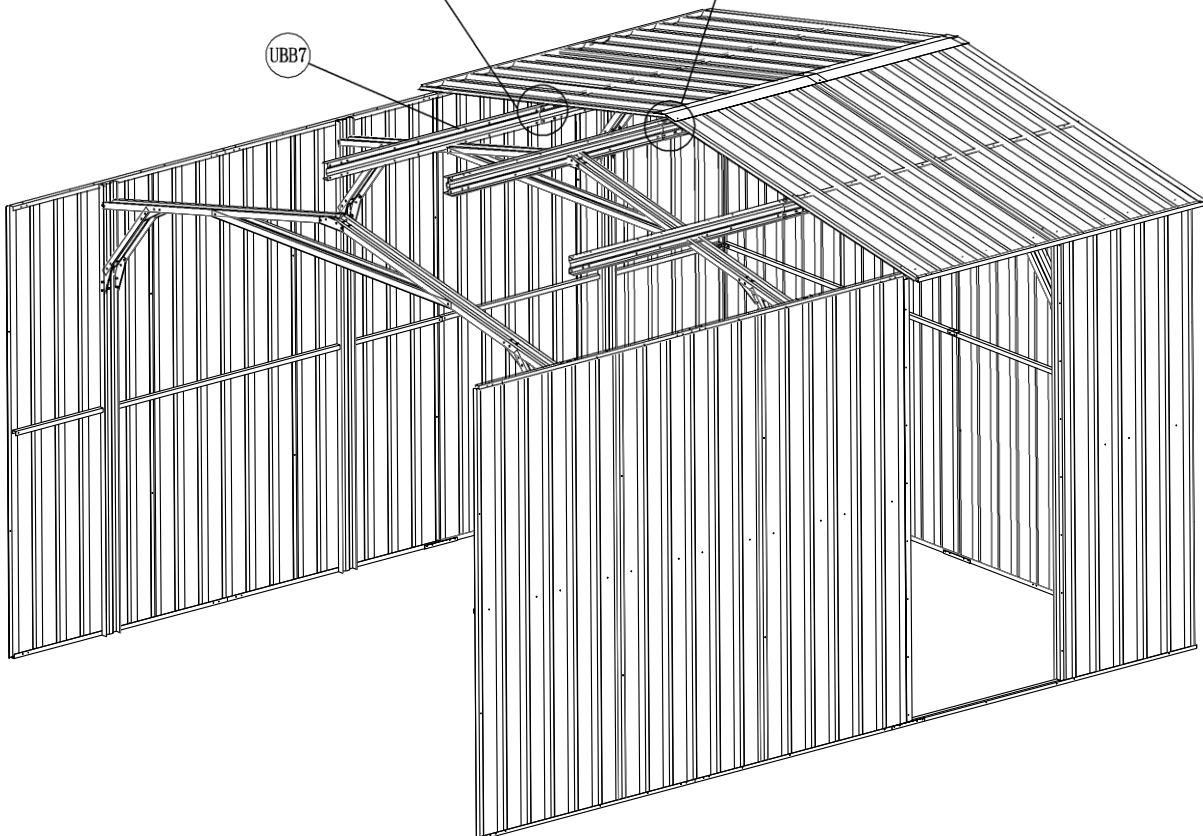
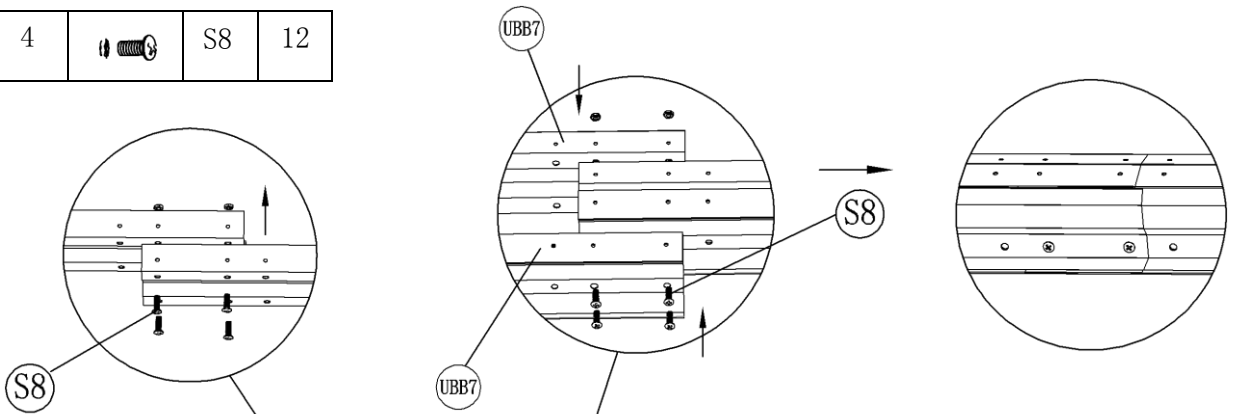

# ENSAMBLAJE DEL MODULAR

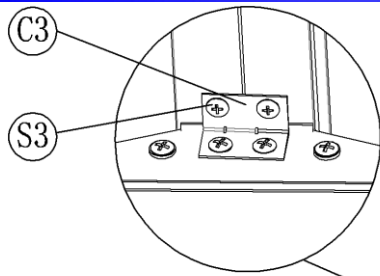

	C3	4		S3	16
	UBB7	4		S8	22

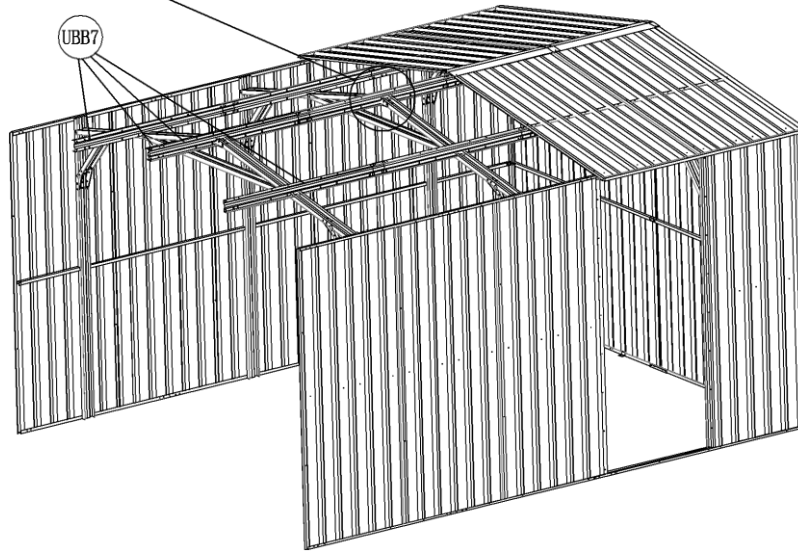

Nota. Puede decidir instalar el panel del techo al final, según las instrucciones de instalación de la casa modular frontal



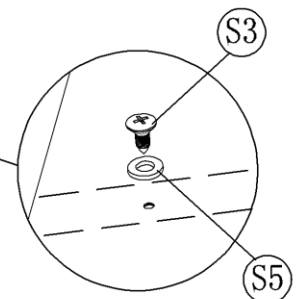
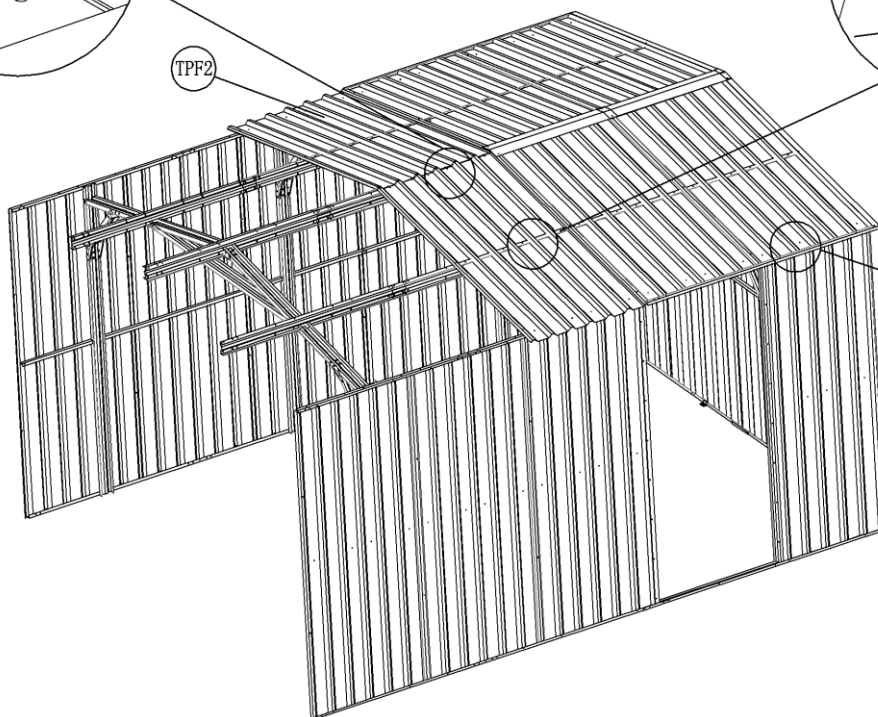
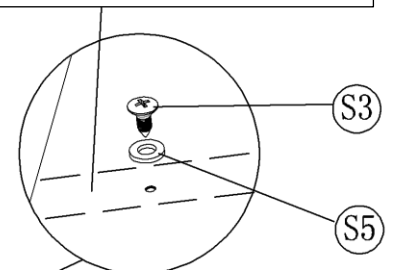
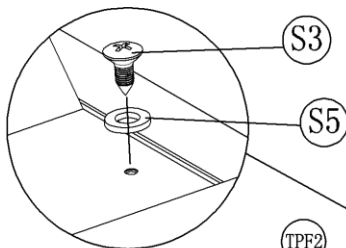

Viga Secundaria

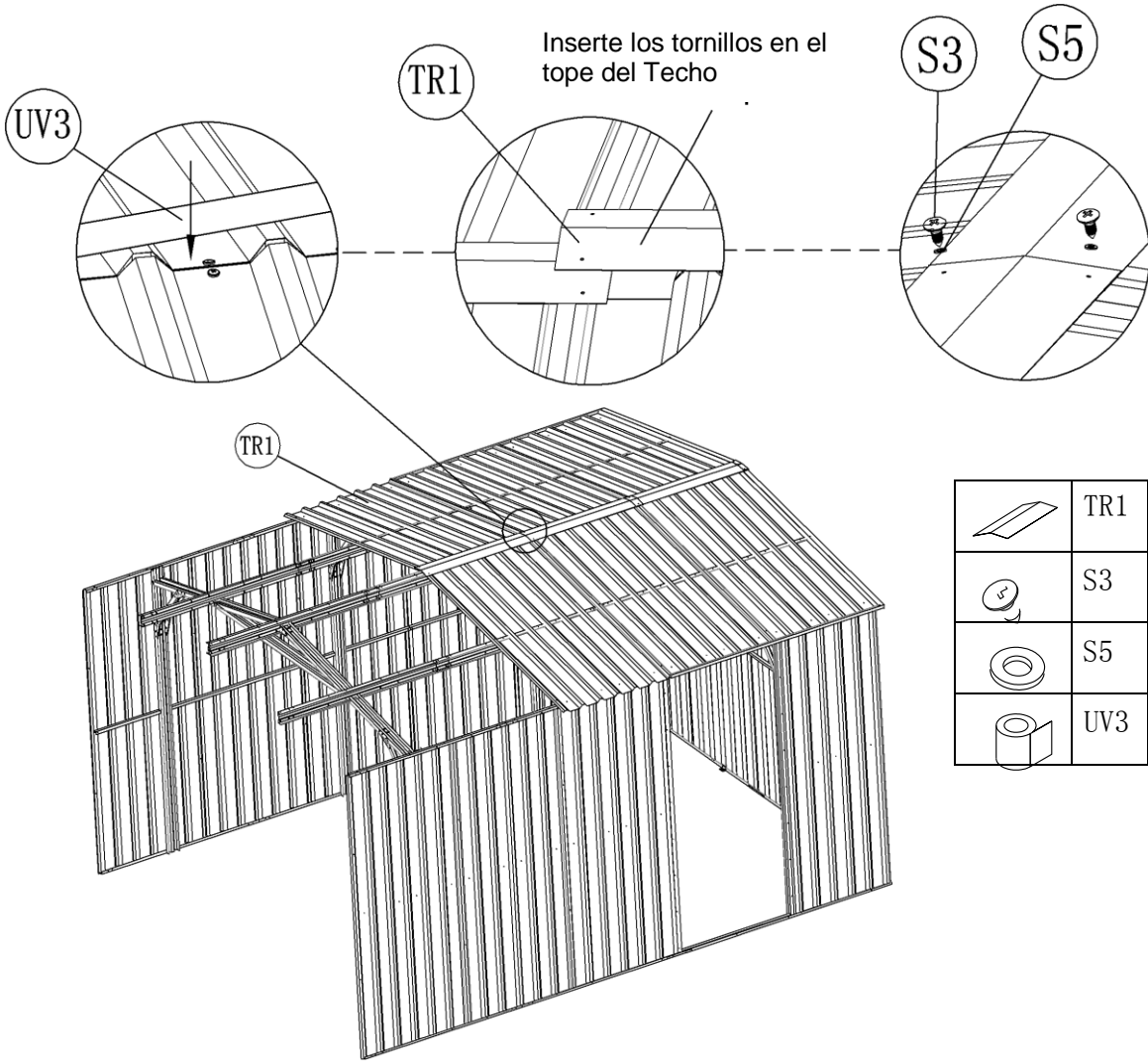

	TPF2	2		
	S3	28		
	S5	28		



# ENSAMBLAJE DEL MODULAR



	TR1	1
	S3	2
	S5	2
	UV3	

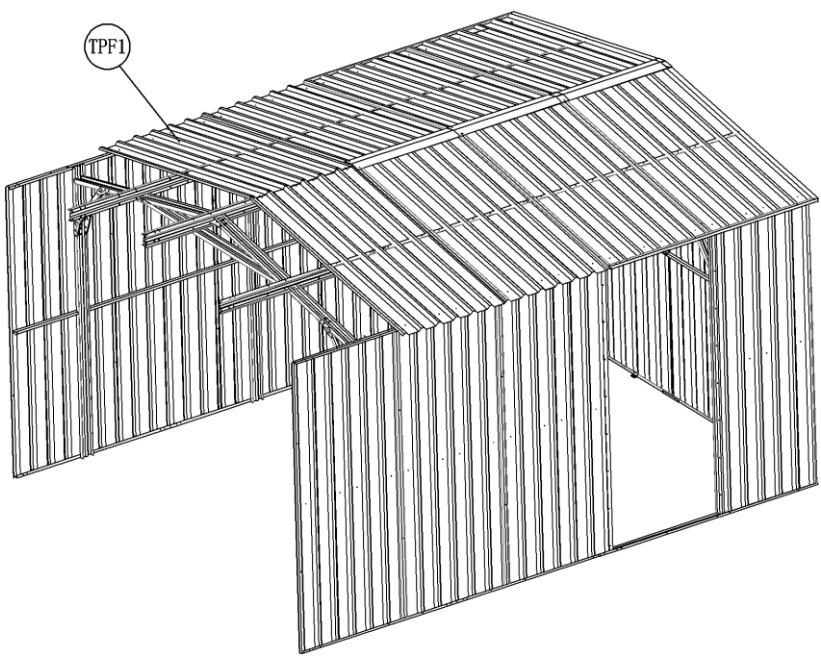



INSTALE AMBOS TPF1 Y A SU VEZ INSTALE TR1



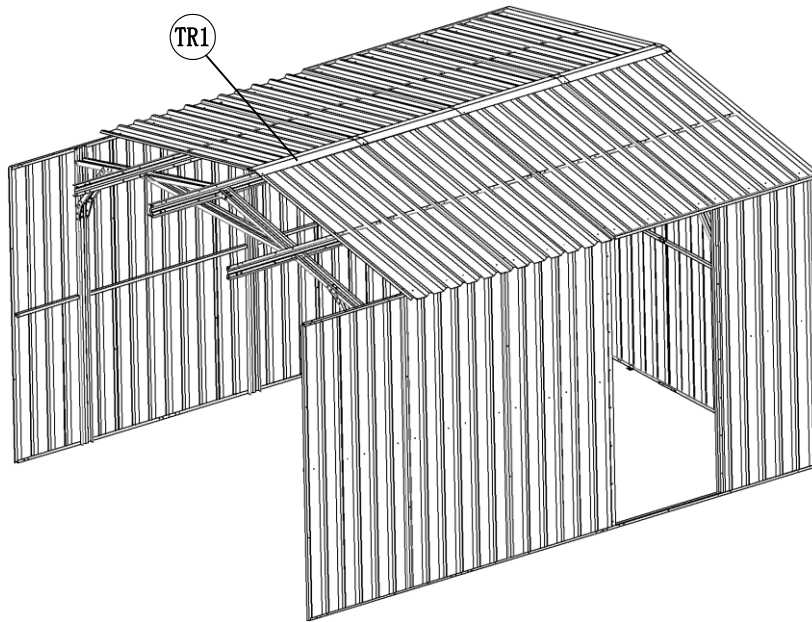





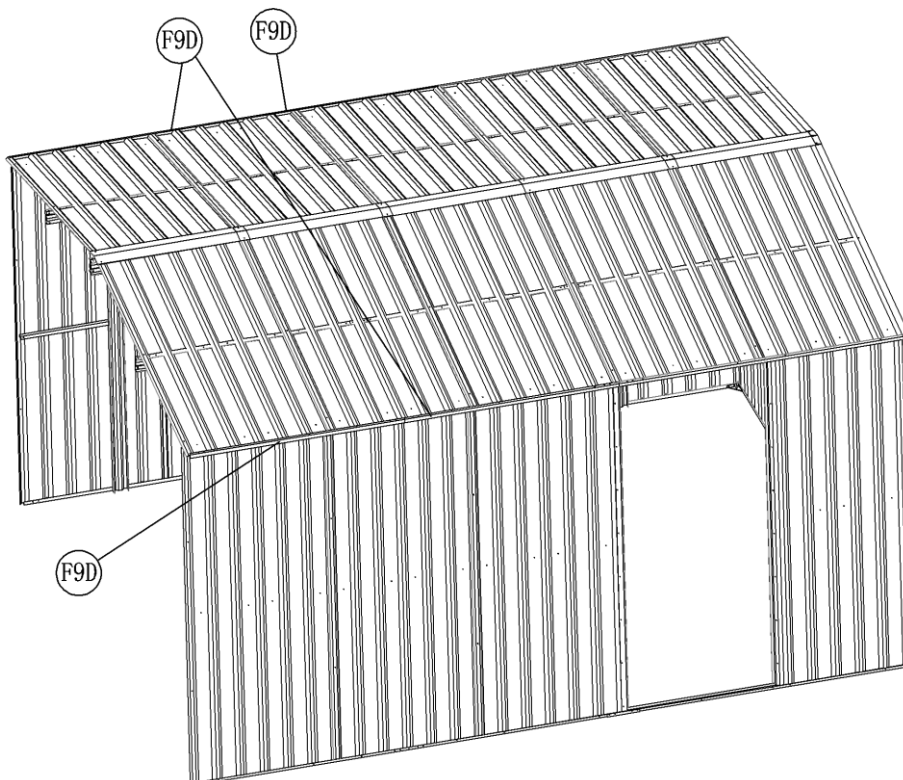

	TPF2	2
	S3	28
	S5	28

# ENSAMBLAJE DEL MODULAR



	TR1	1
	S3	2
	S5	2
	UV3	1



	TPF2	2
	TR1	1
	S3	30
	S5	30
	UV3	
	F9D	4
	J1	4