

INSTRUCCIONES DE INSTALACIÓN

Bosen Industrial. www.bosen.cl

CASA MODULAR ---MG14M

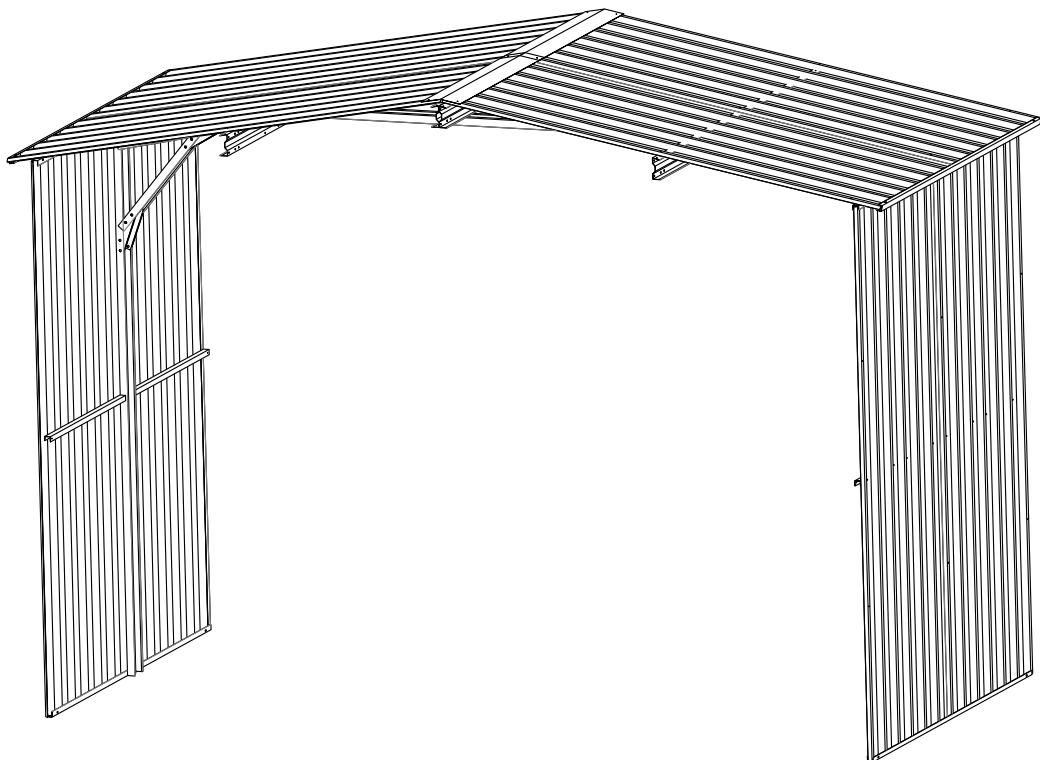



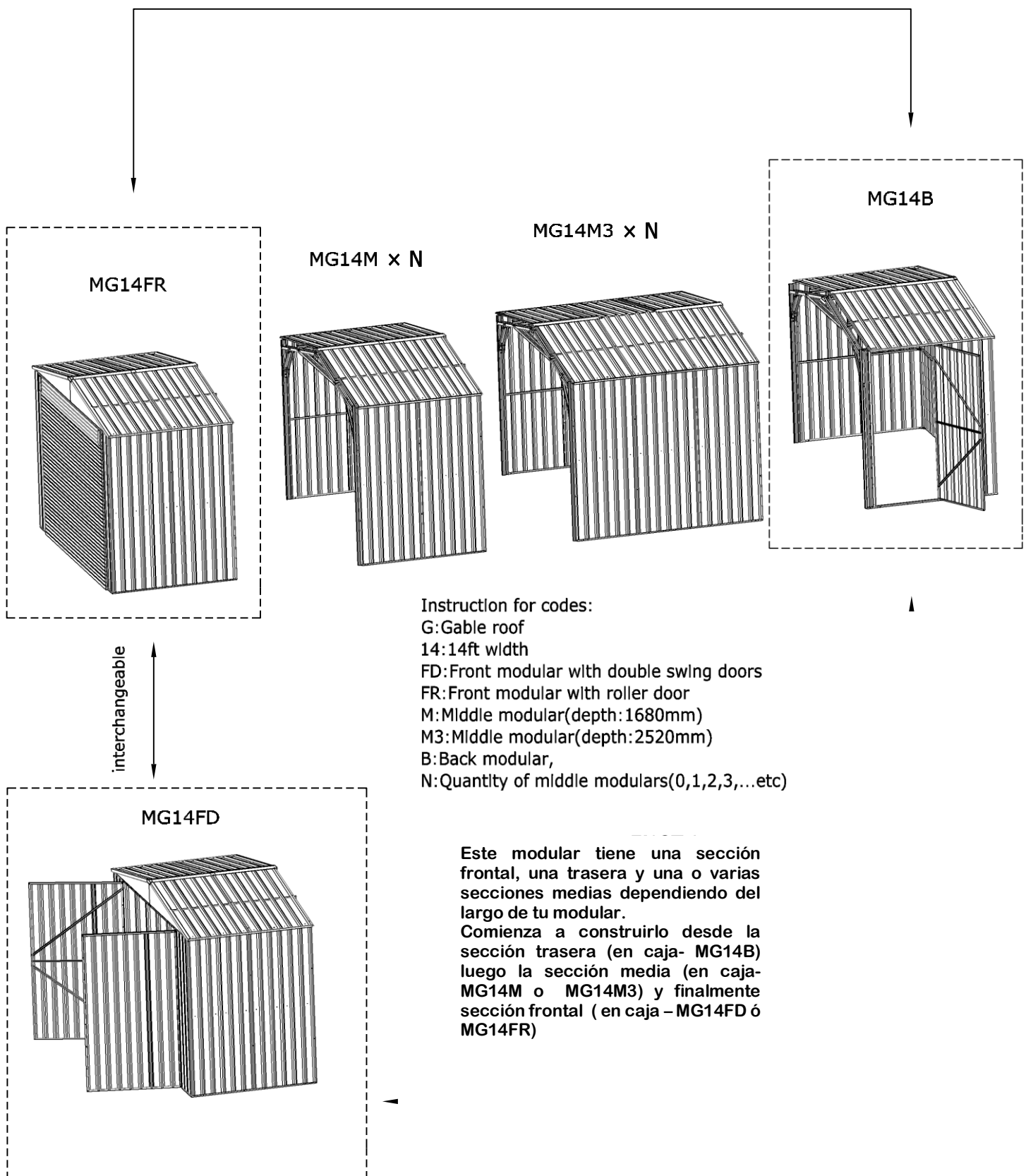

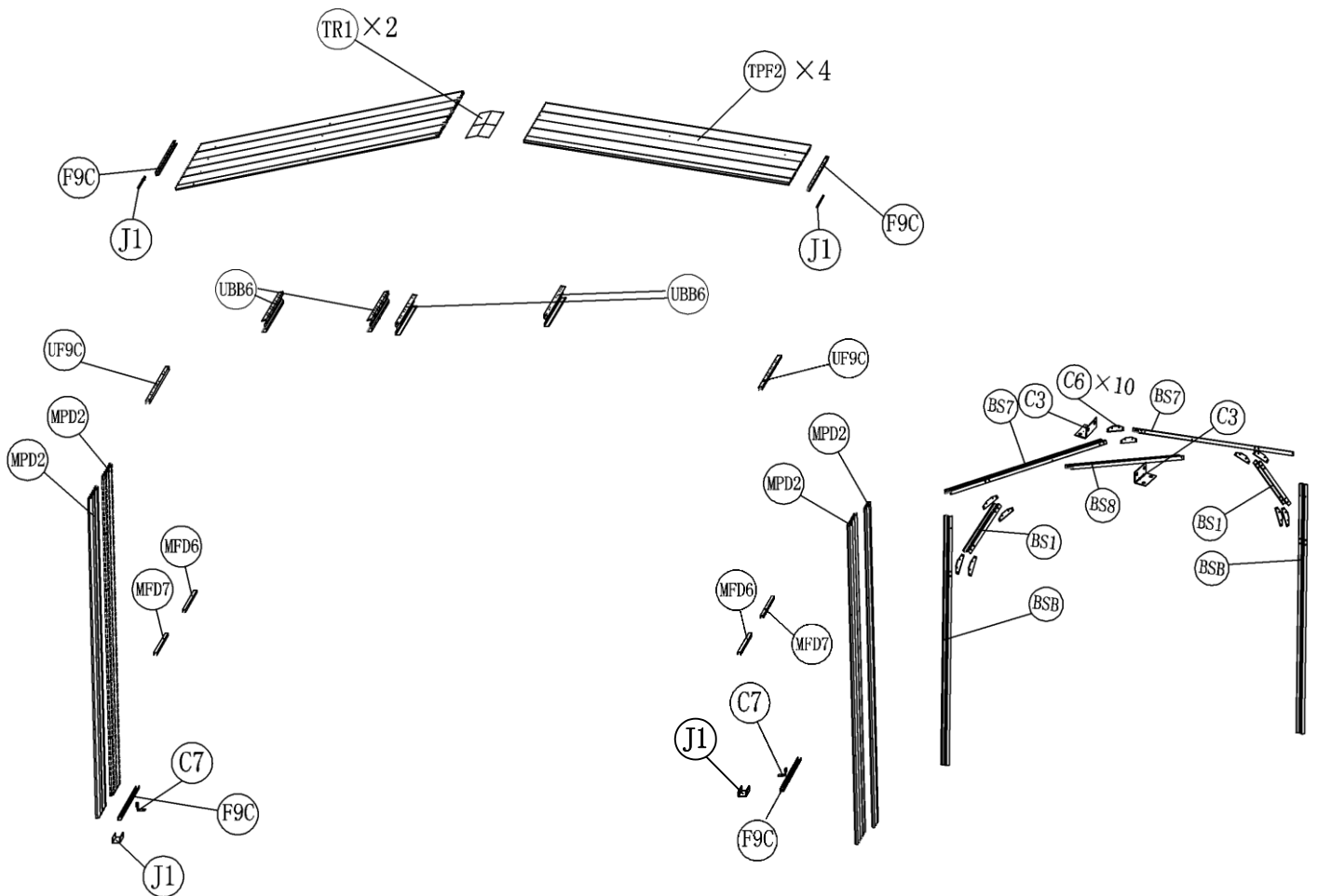
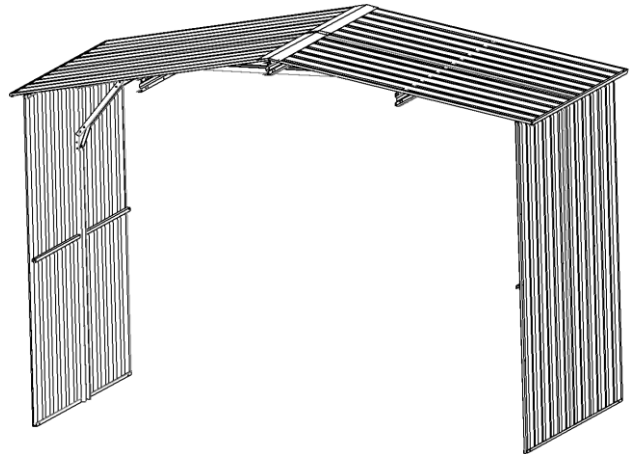



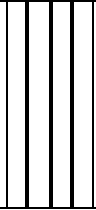
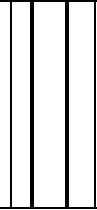
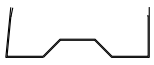
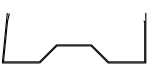
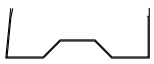
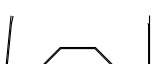
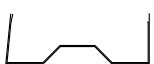

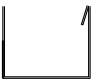



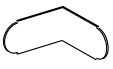

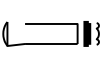
COMO ENSAMBLAR EL MODULAR









LISTADO DE PARTES

| picture | Part No. | QTY | Cl 1 | picture | Part No. | QTY | Cl 1 |
|---|----------|-----|------|---|----------|-----|------|
|  | MPD2 | 4 | |  | TPF2 | 4 | |
|  | UBB6 | 4 | |  | BSB | 2 | |
|  | BS7 | 2 | |  | BS1 | 2 | |
|  | BS8 | 1 | |  | TR1 | 2 | |
|  | F9C | 4 | |  | UF9C | 2 | |
|  | MFD6 | 2 | |  | MFD7 | 2 | |
|  | S3 | 120 | |  | C2 | 4 | |
|  | C3 | 2 | |  | C7 | 4 | |
|  | S11 | 6 | |  | S10 | 48 | |
|  | S5 | 60 | |  | S8 | 18 | |
|  | L3 | 14 | |  | J1 | 6 | |
|  | C6 | 10 | |  | J2 | 2 | |
|  | C8 | 2 | | | | | |

EMSAMBLAJE DEL MODULAR

EMSAMBLAJE DE PARED

| | | | | | |
|---|------|---|---|------|---|
|  | MPD2 | 2 |  | UF9C | 1 |
|  | F9C | 1 |  | S3 | 2 |
|  | L3 | 2 | | | |

×2

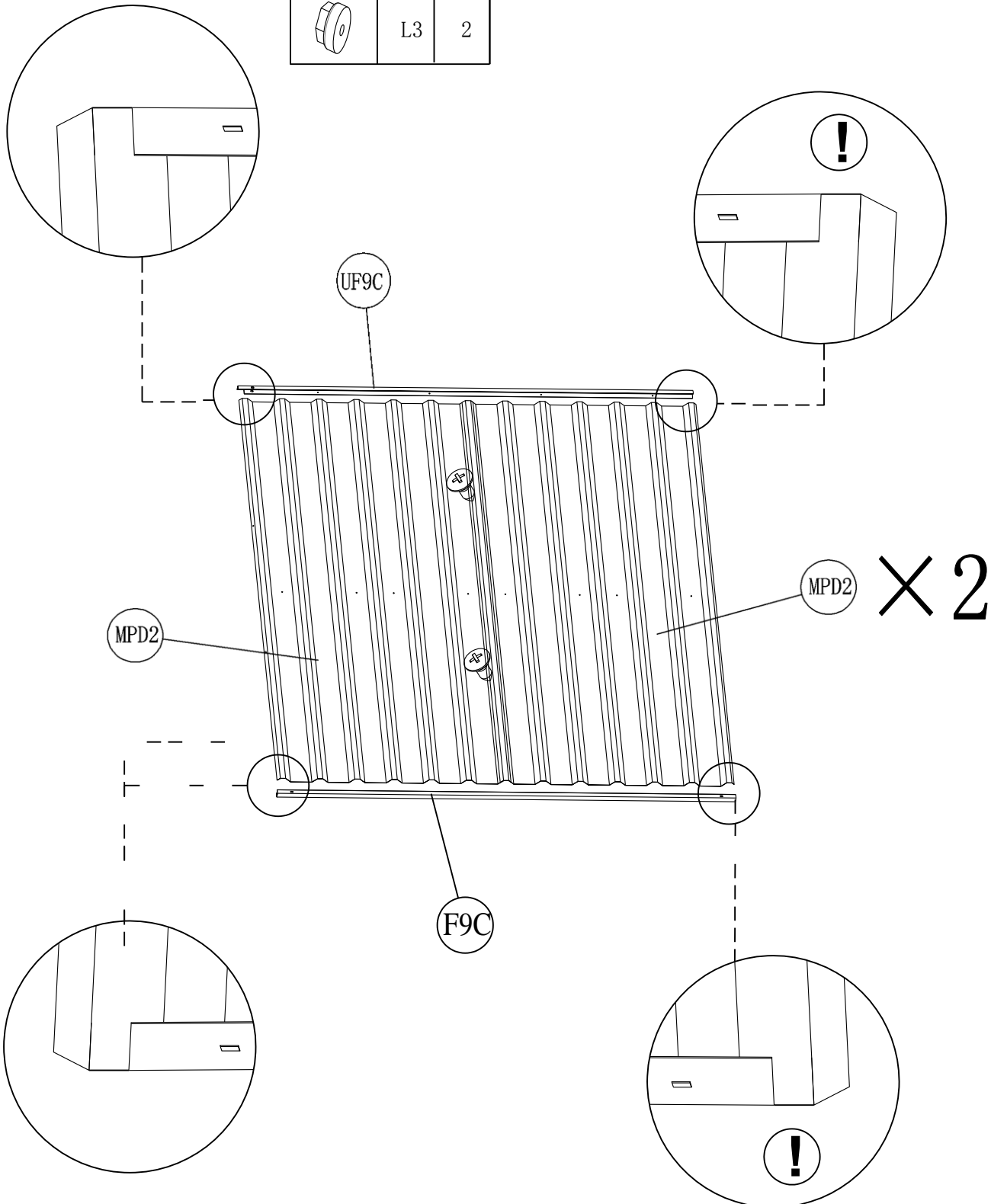

MPD2 ×2

EMSAMBLAJE DEL SOPORTE

Coloque los pernos a través de los agujeros pre-perforados, use arandelas y tuercas, apriete ligeramente en esta etapa

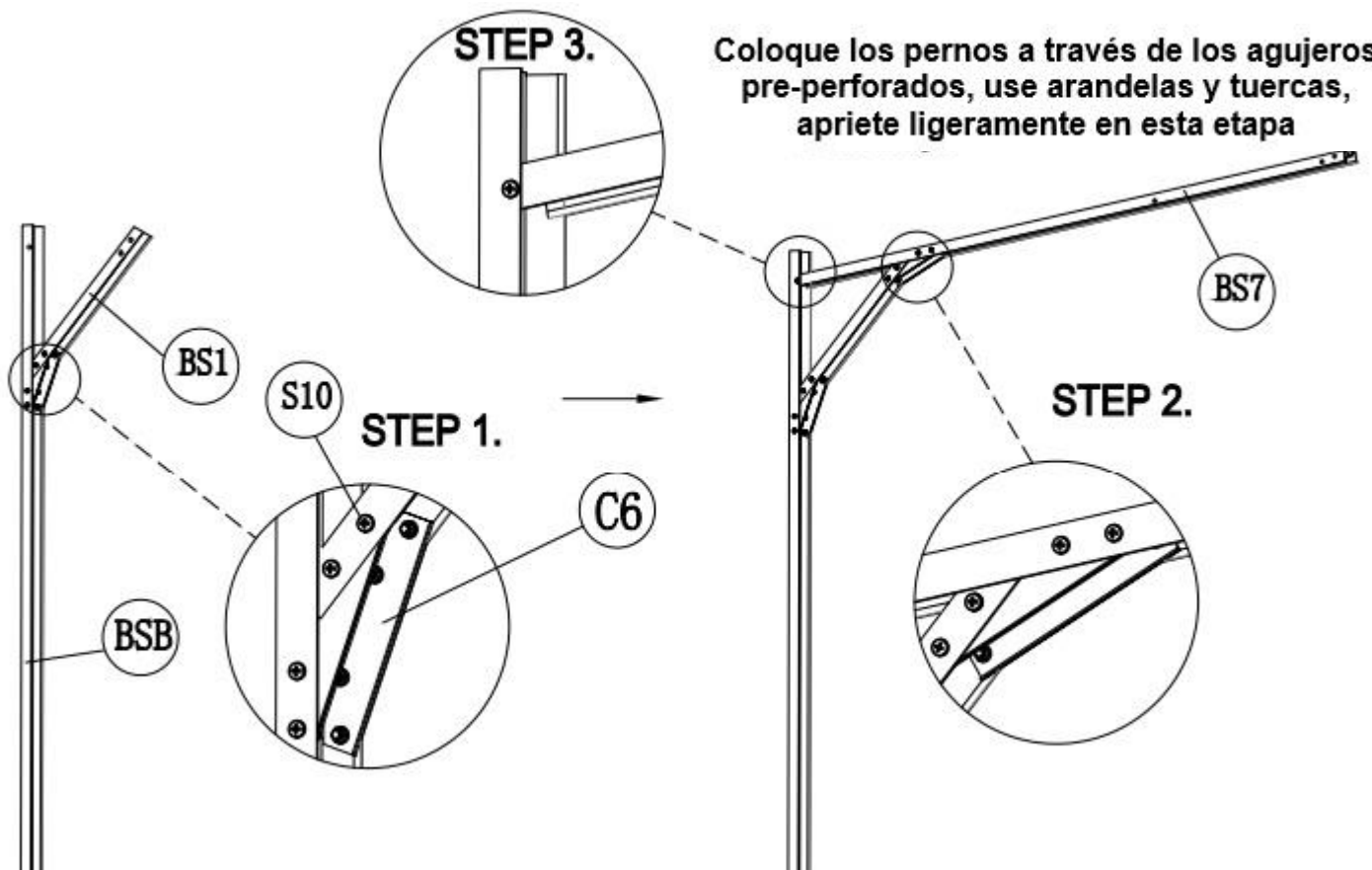

Repita el proceso de ensamblado del lado izquierdo, hacia el lado derecho, usando las partes tal como se muestra en el diseño

PASO 5

PASO 4

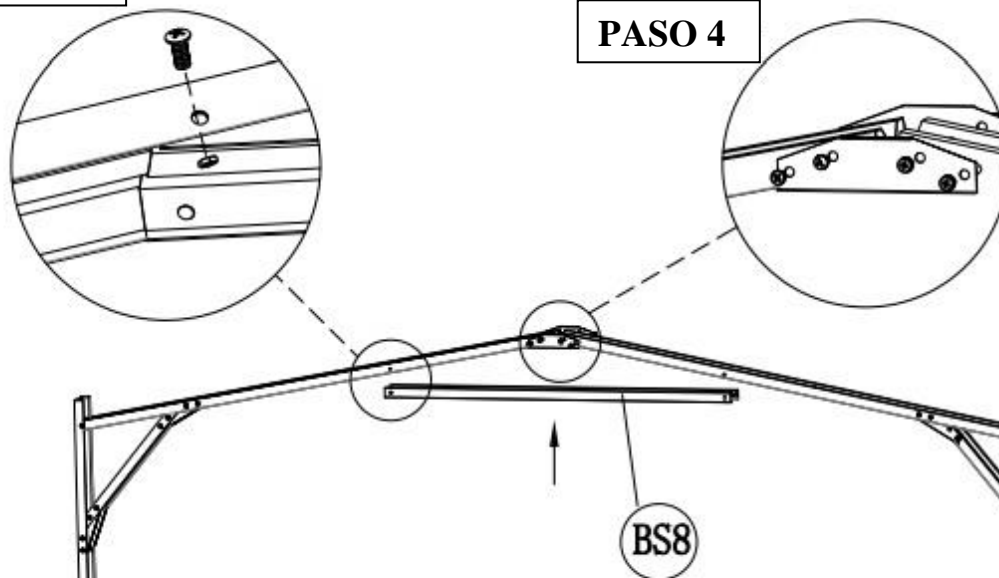





| | | |
|--|-----|----|
| | BSB | 2 |
| | BS1 | 2 |
| | BS7 | 2 |
| | BS8 | 1 |
| | S10 | 48 |
| | C6 | 10 |

Repita nuevamente, usando las partes como el diseño mostrado

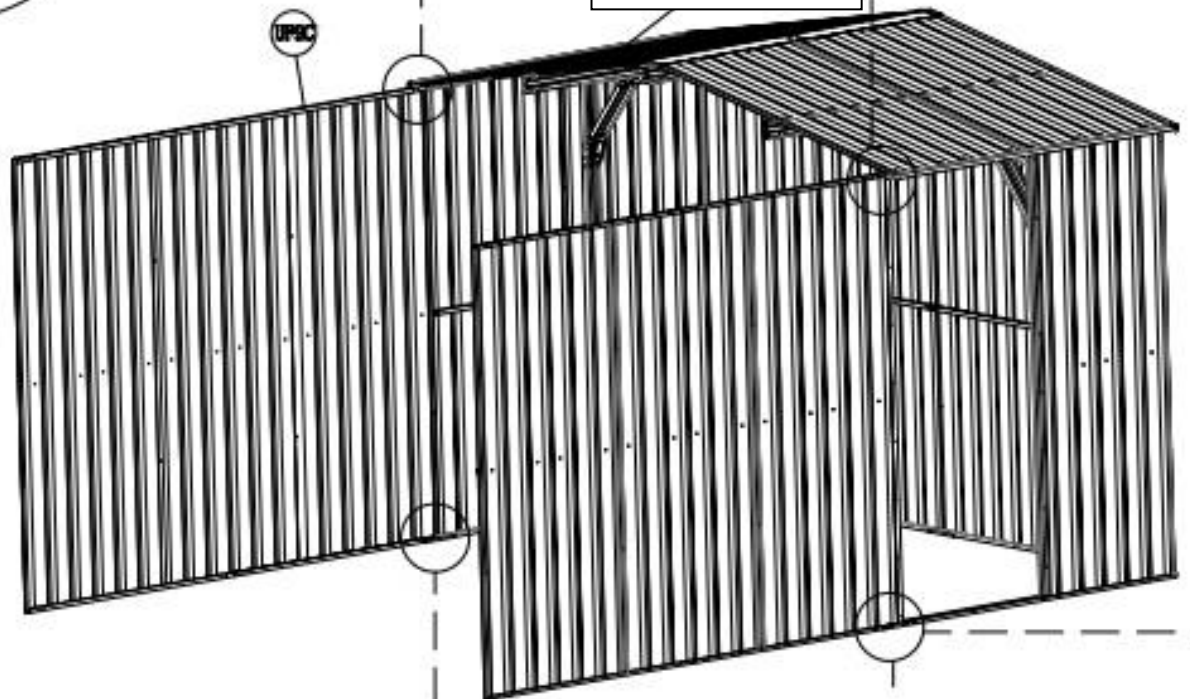
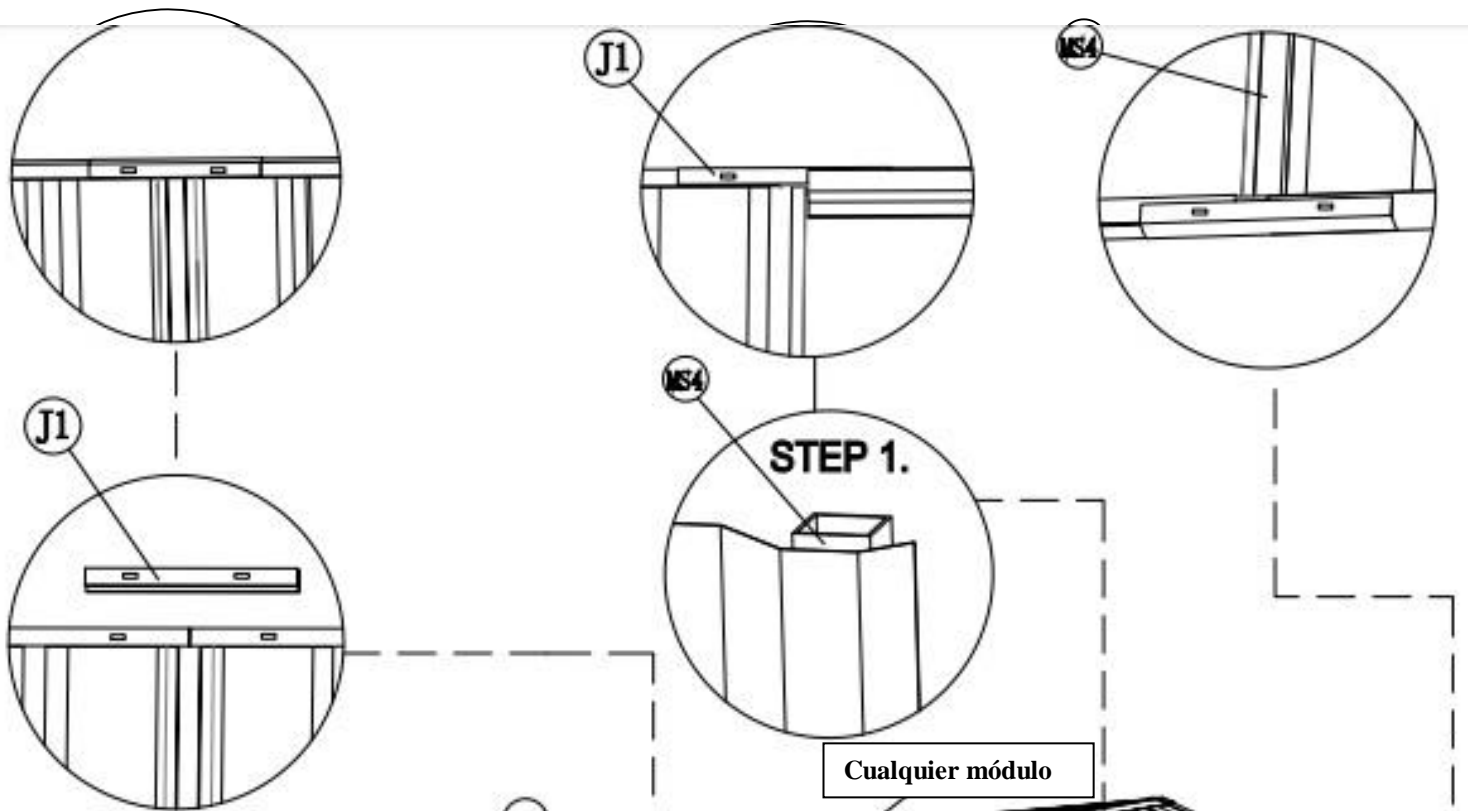
Apriete todos los tornillos en esta etapa.

EMSAMBLAJE DEL MODULAR



| | | |
|--|----|---|
|  | J1 | 3 |
|  | S3 | 2 |
|  | L3 | 2 |

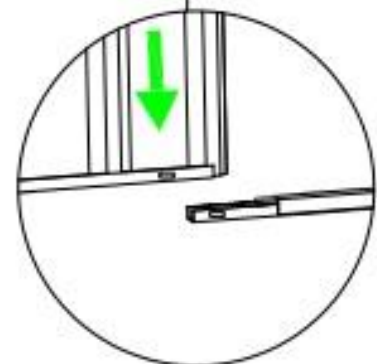
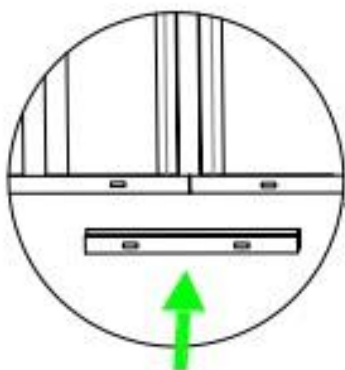

EMSAMBLAJE DEL MODULAR

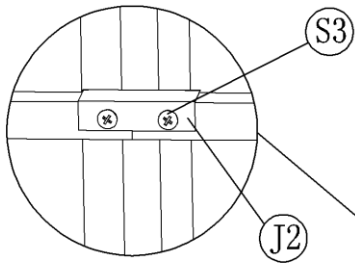

| | | | | | |
|--|------|---|--|------|---|
| | MFD6 | 1 | | J2 | 1 |
| | S3 | 8 | | MFD7 | 1 |

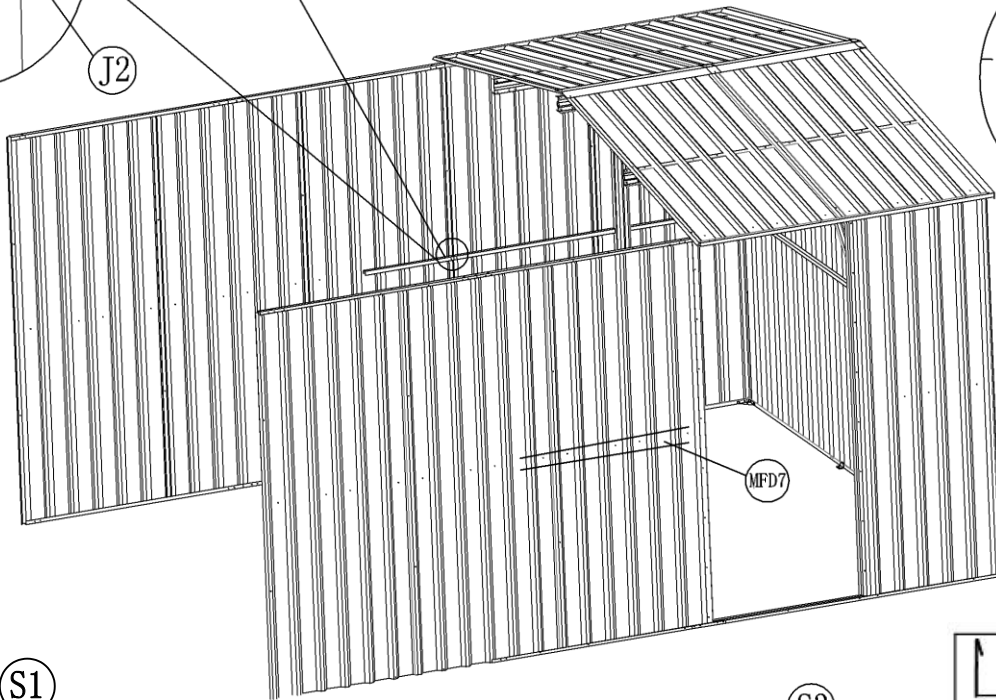
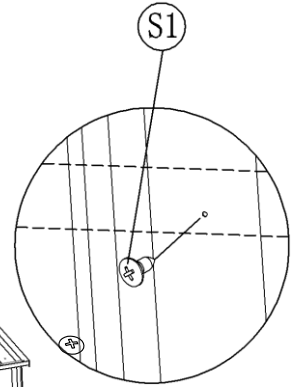

S1

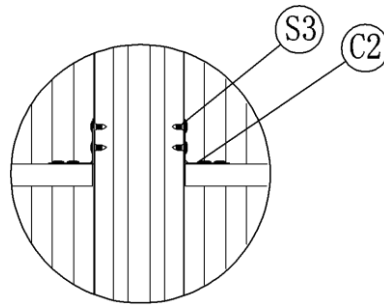
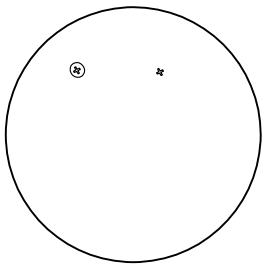

| | | |
|--|------|----|
| | MFD6 | 1 |
| | MFD7 | 1 |
| | C2 | 4 |
| | S3 | 36 |
| | L3 | 8 |
| | C8 | 2 |

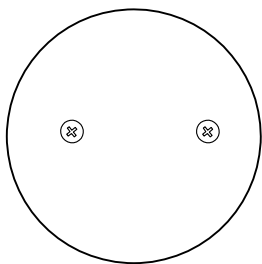

S1

SOPORTE

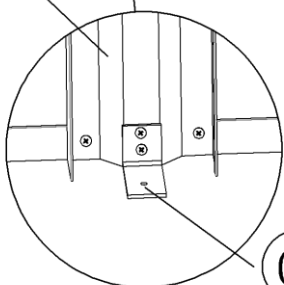

C8

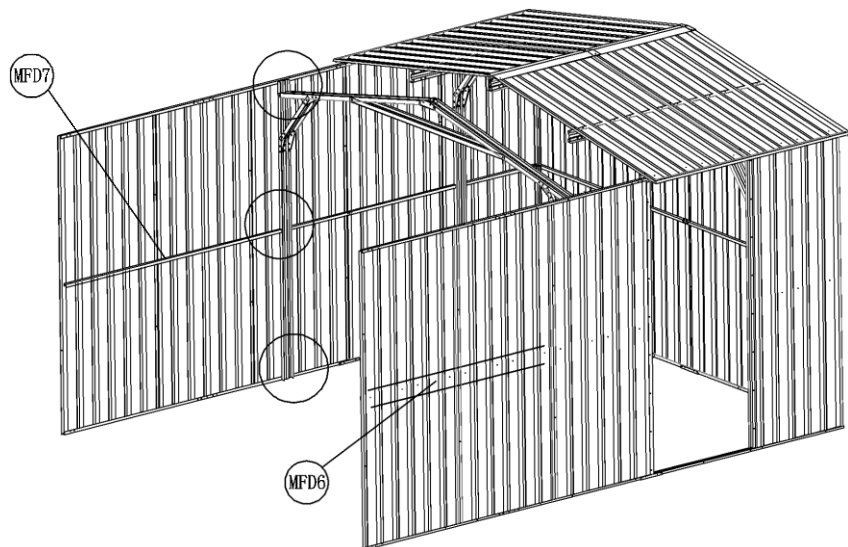

EMSAMBLAJE DEL MODULAR

| | | | | | |
|---|------|---|---|----|----|
|  | UBB6 | 4 |  | S8 | 18 |
|---|------|---|---|----|----|

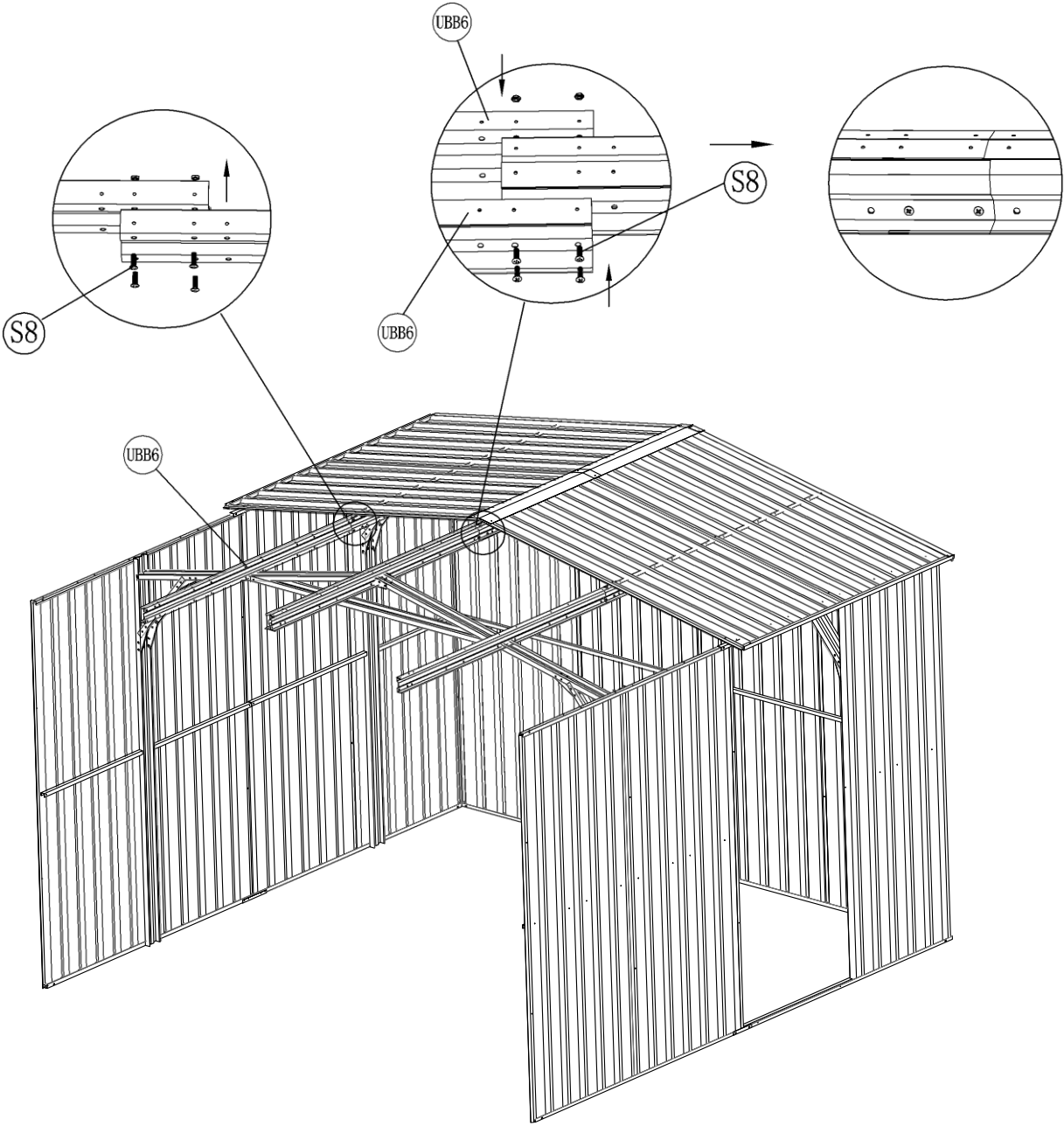

EMSAMBLAJE DEL MODULAR

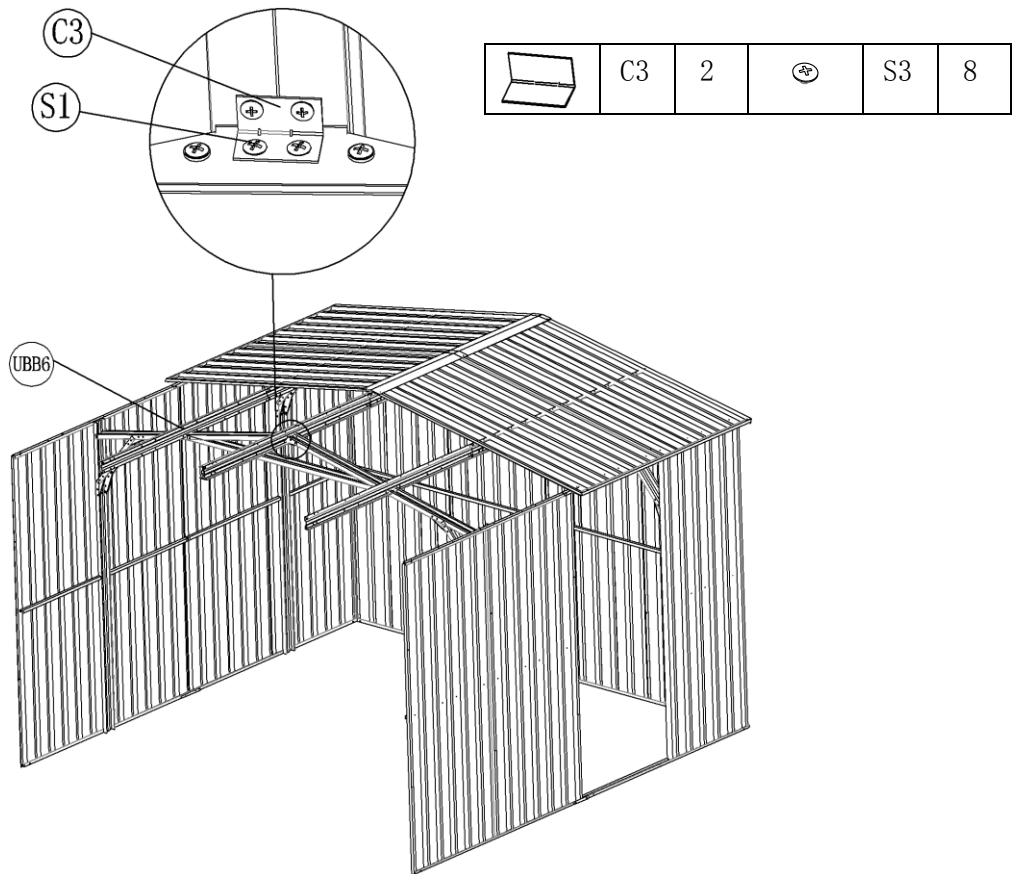



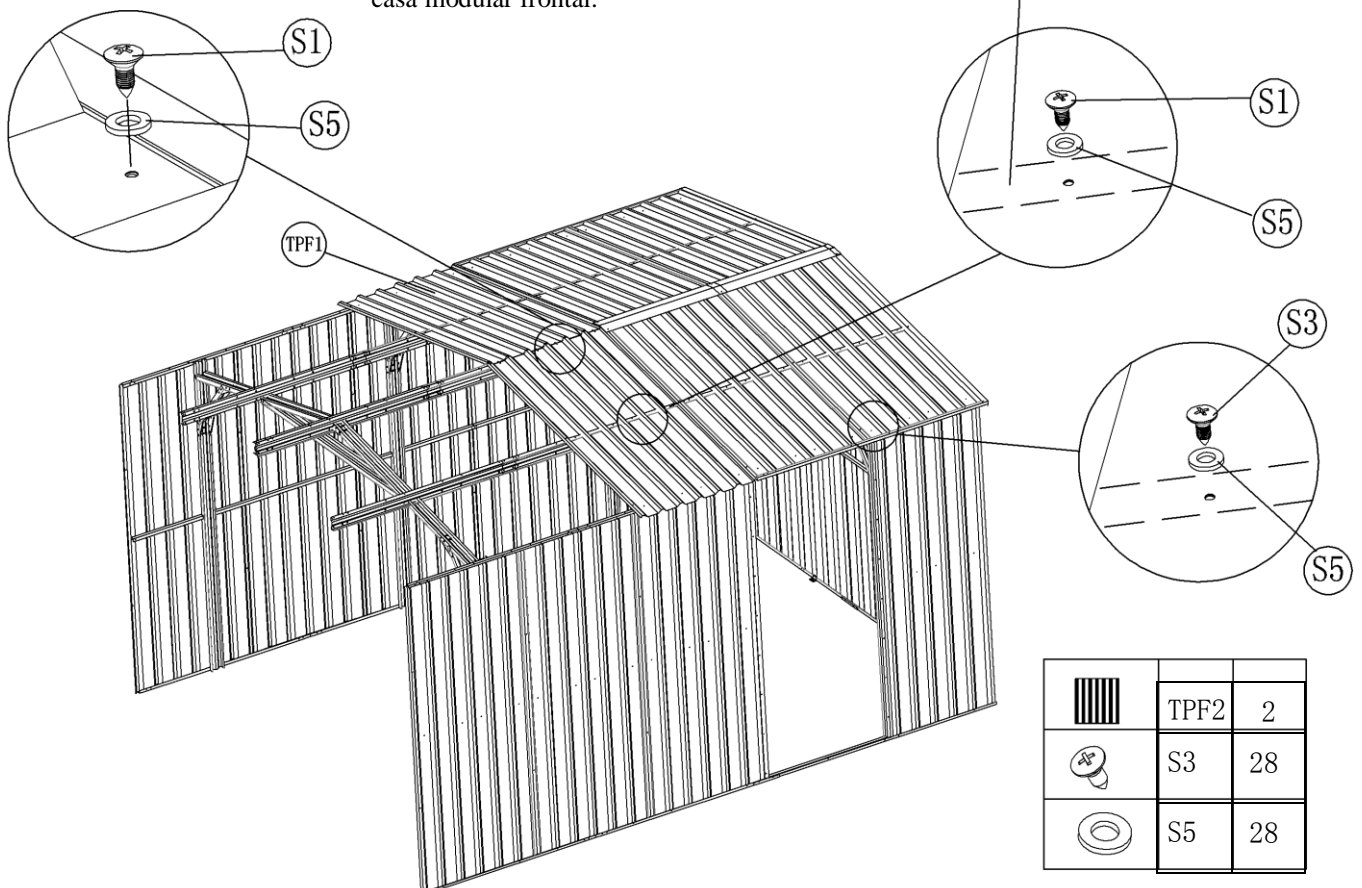

NOTA: Puede optar por instalar el panel del techo al final siguiendo las instrucciones de instalación de la casa modular frontal.

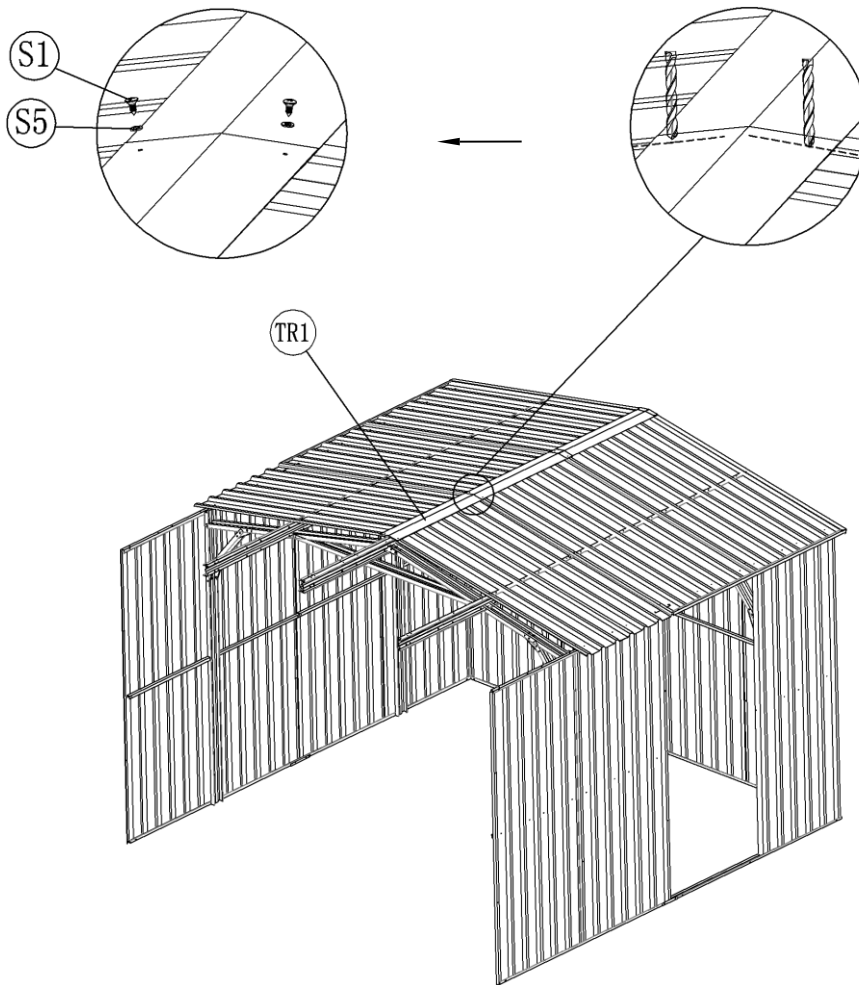

EMSAMBLE DEL MODULAR







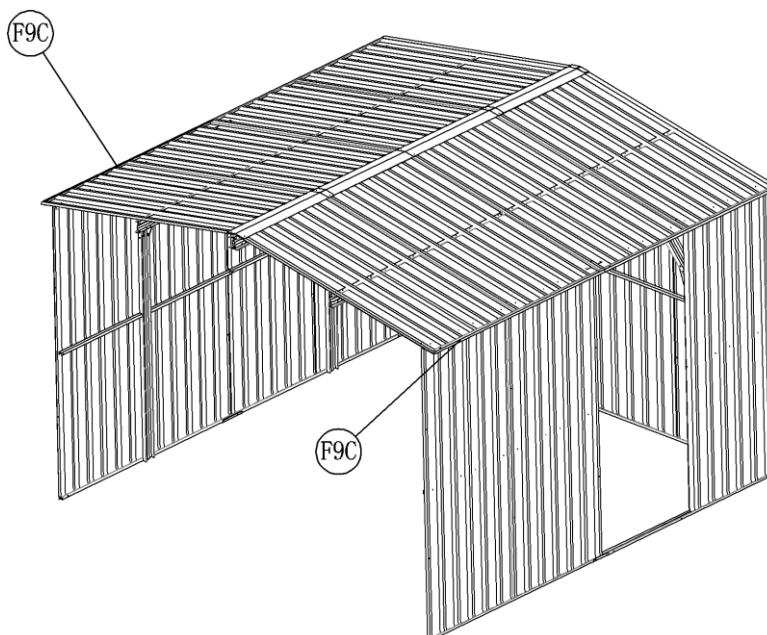

INSERTE LOS TORNILLOS EN EL CENTRO DEL TOPE

| | | |
|---|-----|---|
|  | TR1 | 1 |
|  | S3 | 2 |
|  | S5 | 2 |
|  | UV3 | |

Por Favor Instale ambos TPF2 y a su vez instale TR1



| | | |
|---|------|----|
|  | TPF2 | 2 |
|  | TR1 | 1 |
|  | S3 | 30 |
|  | S5 | 30 |
|  | UV3 | |
|  | F9C | 2 |
|  | J1 | 2 |