

INSTRUCCIONES DE INSTALACION

Bosen Industrial www.bosen.cl

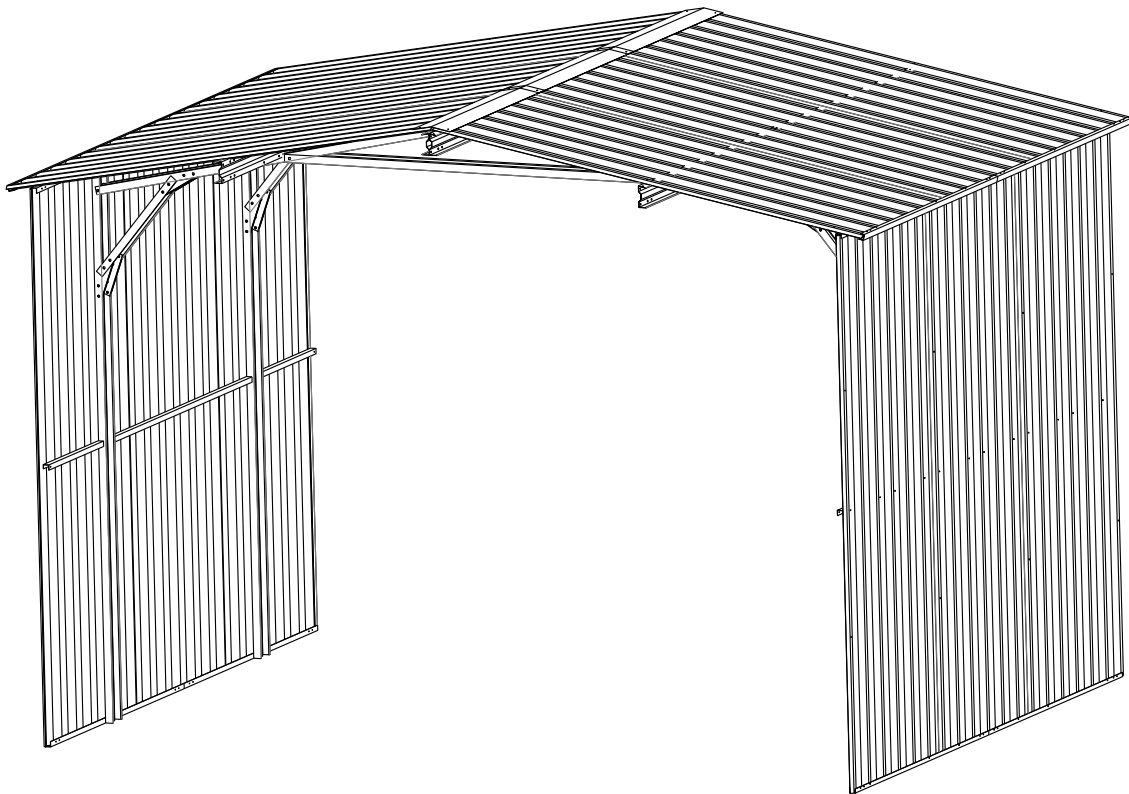





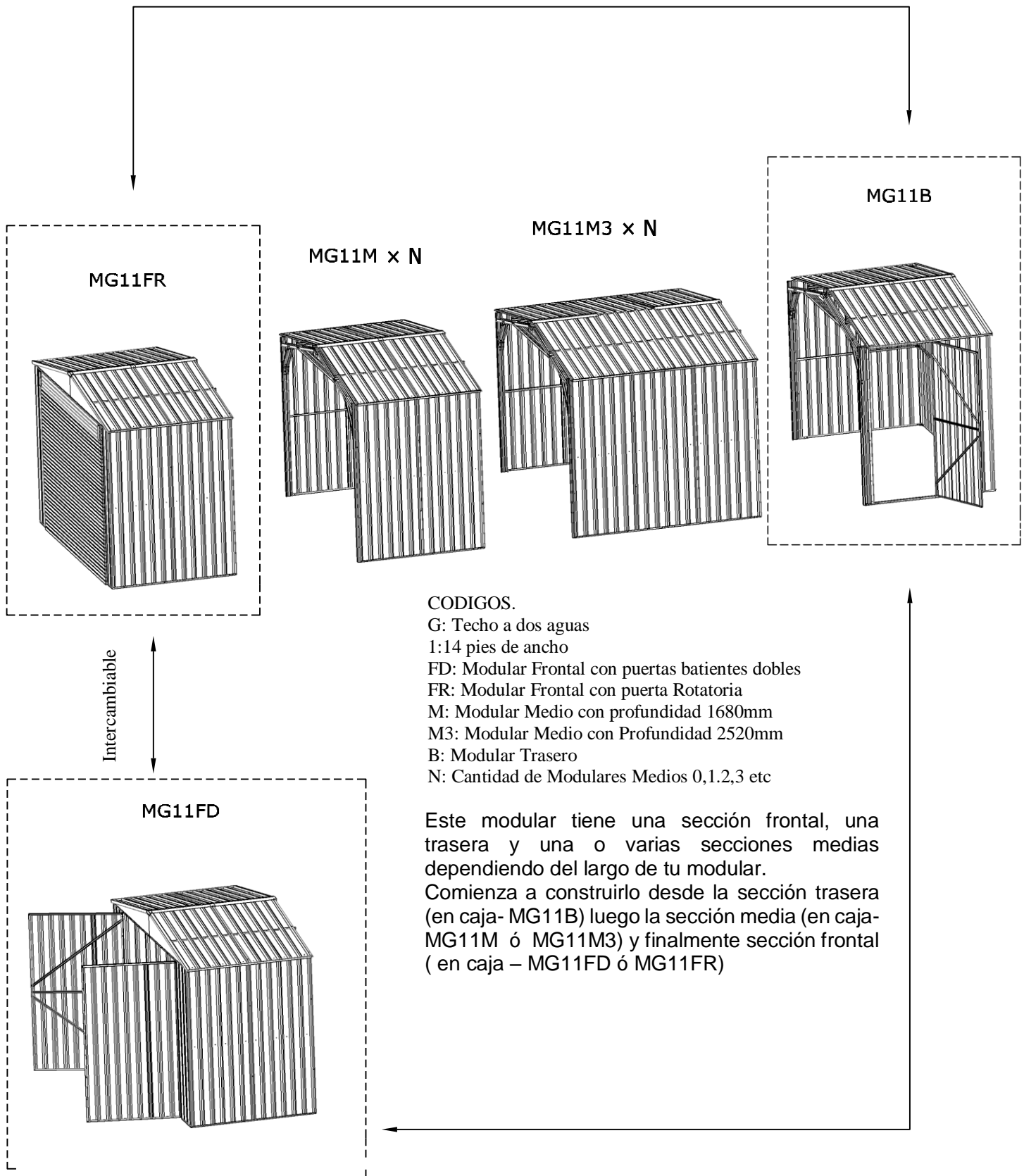

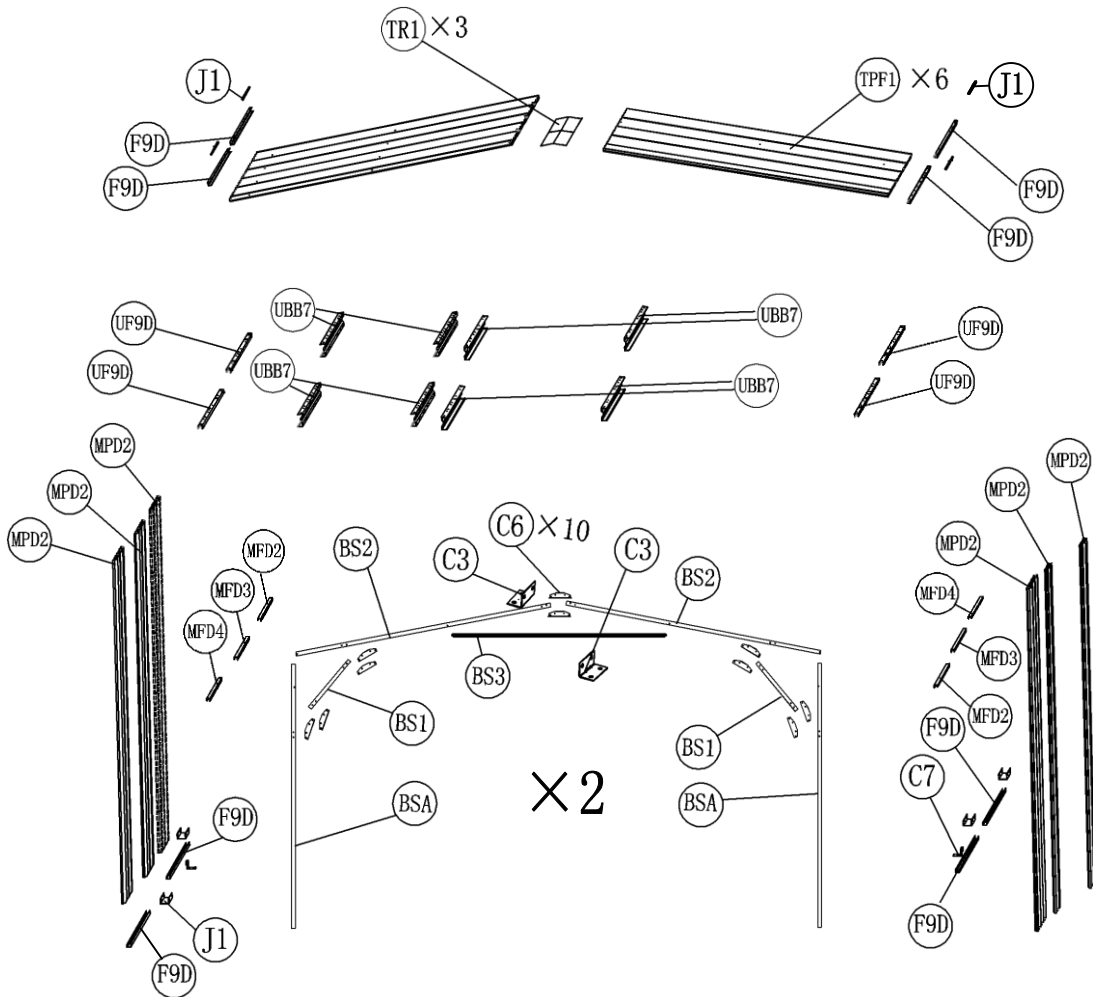
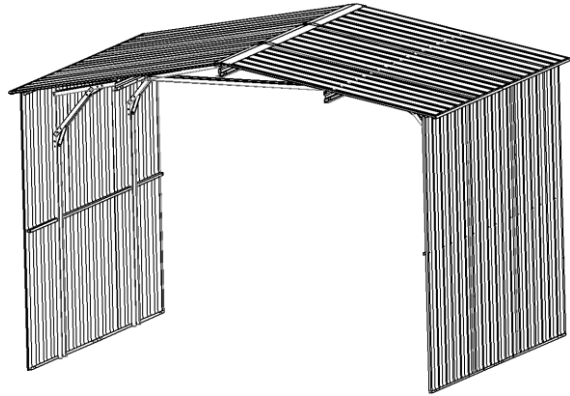

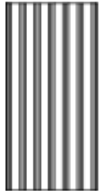
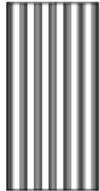
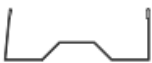
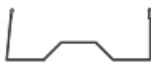
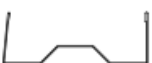
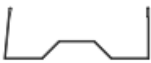
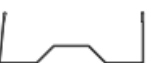







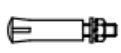

CASA MODULAR – MG11M3



COMO PUEDE SER UNIDO EL MODULAR











| IMAGEN | No PARTE | CANT. | CHECK | IMAGEN | No PARTE | CANT. | CHECK |
|---|----------|-------|-------|--|----------|-------|-------|
|  | MPD2 | 6 | |  | TPF1 | 6 | |
|  | UBB7 | 8 | |  | BSA | 4 | |
|  | BS2 | 4 | |  | BS1 | 4 | |
|  | BS3 | 2 | |  | TR1 | 3 | |
|  | F9D | 8 | |  | UF9D | 4 | |
|  | MFD2 | 2 | |  | MFD3 | 2 | |
|  | MFD4 | 2 | |  | C2 | 8 | |
|  | C3 | 4 | |  | C7 | 4 | |
|  | S11 | 8 | |  | S10 | 96 | |
|  | S5 | 90 | |  | S3 | 198 | |
|  | L3 | 26 | |  | S8 | 34 | |
|  | C6 | 20 | |  | J1 | 12 | |
|  | J2 | 2 | |  | C8 | 4 | |

ENSAMBLAJE DEL MODULAR

ENSAMBLAJE DE PAREDES

| | | | | | |
|---|------|---|---|--|---|
|  | MPD2 | 3 |  | | 2 |
|  | UF9D | 2 |  | | 4 |
|  | J1 | 2 |  | | 4 |

×2

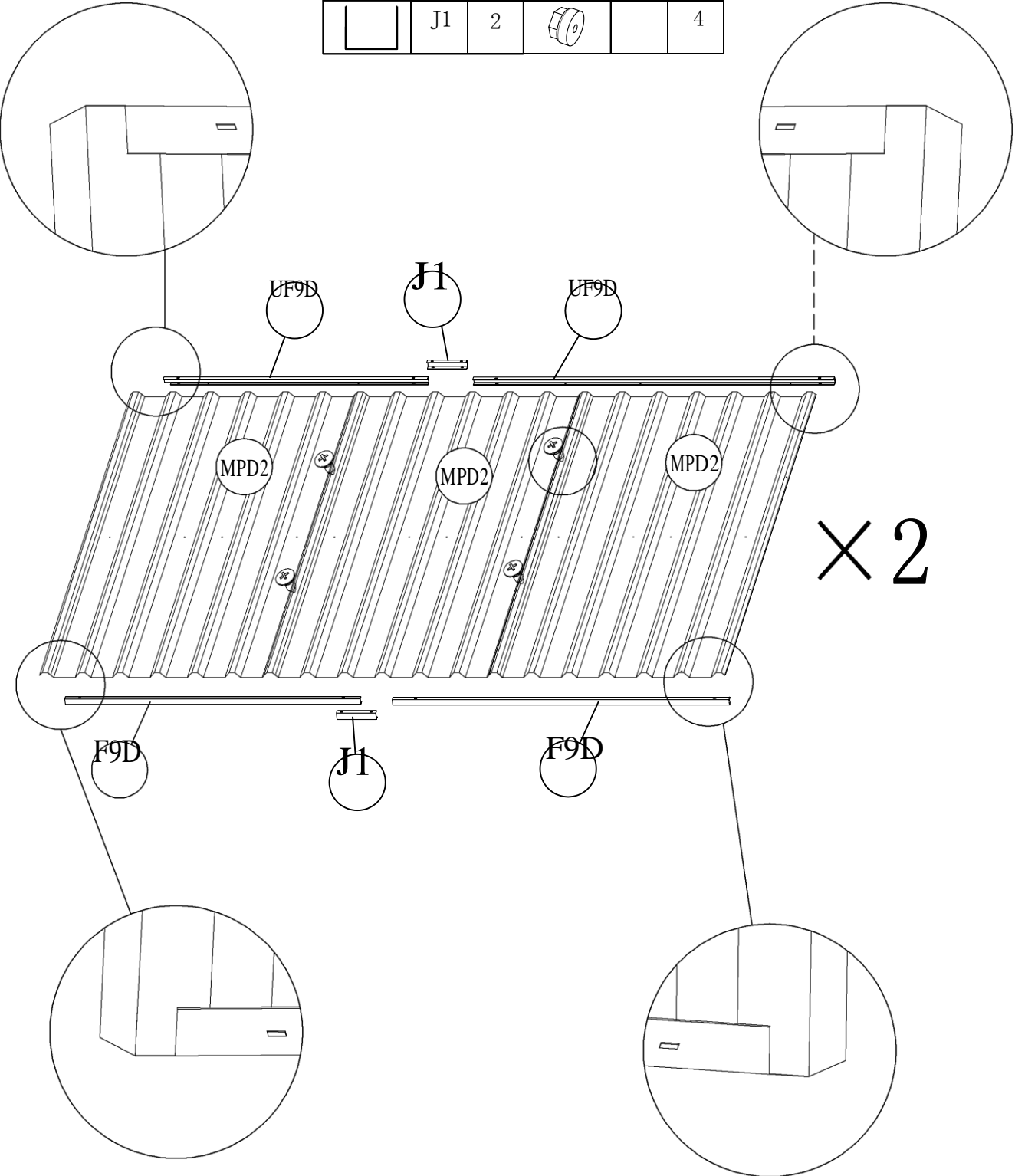

×2

ENSAMBLAJE DEL SOPORTE

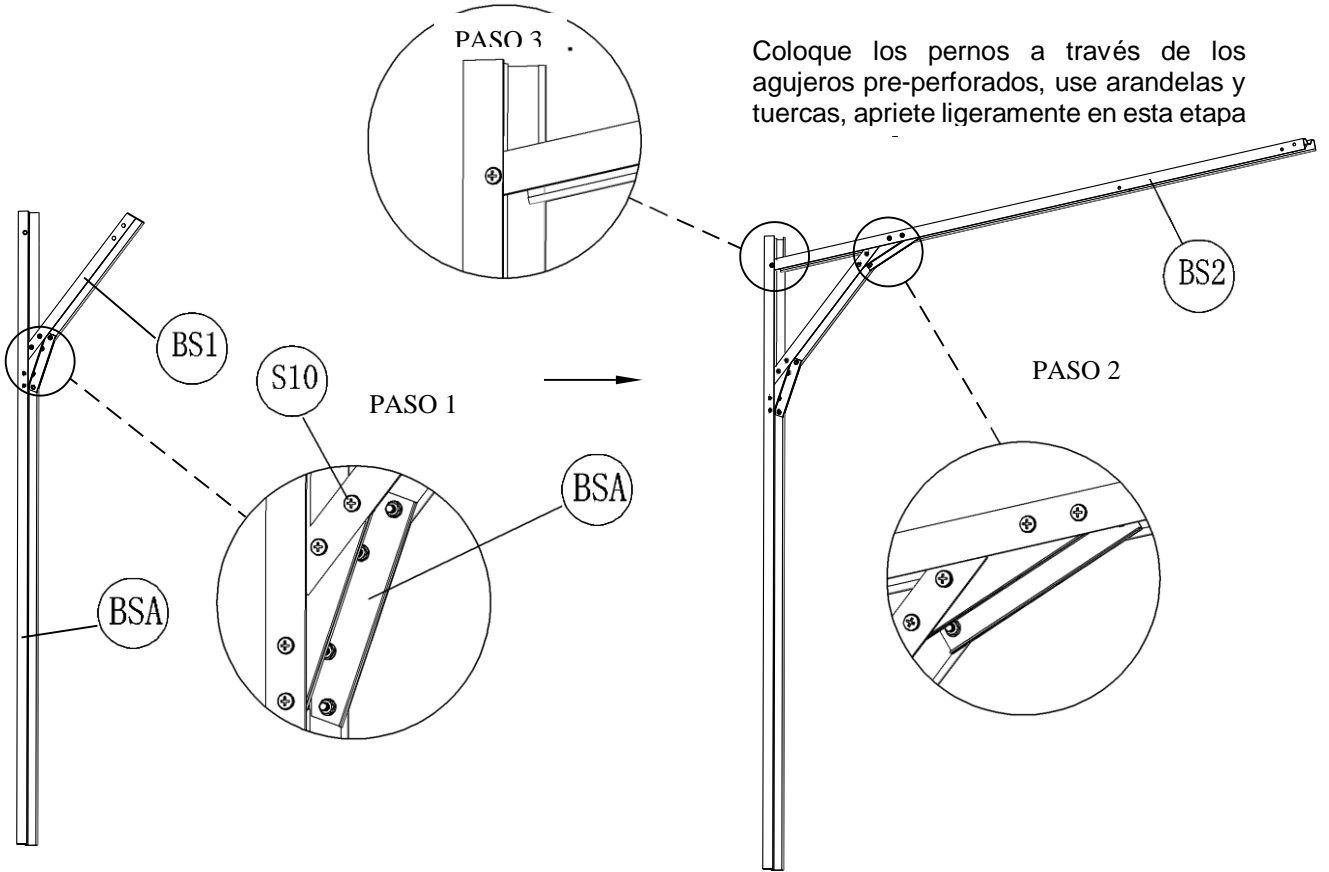

PASO 5

Repita el proceso de ensamblaje del lado izquierdo, para el lado derecho, usando las partes como se muestra en el diseño.

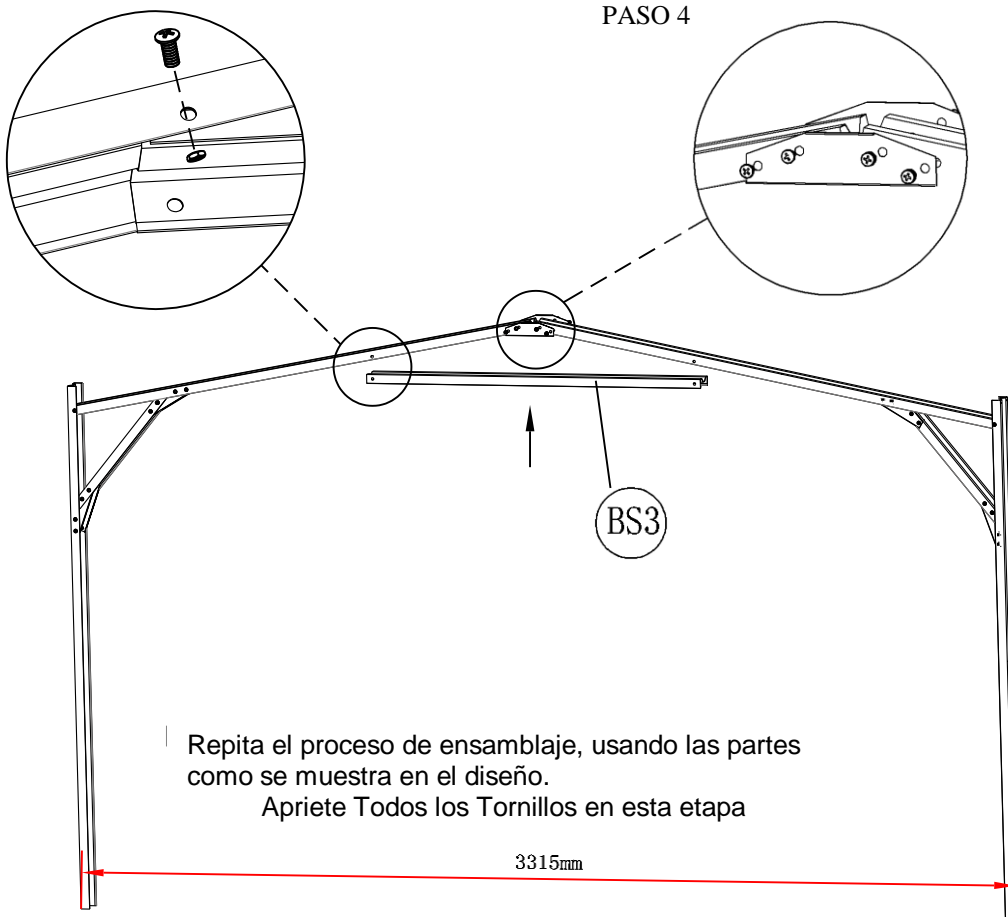





| | | |
|--|-----|----|
| | BSA | 2 |
| | BS1 | 2 |
| | BS2 | 2 |
| | BS3 | 1 |
| | S10 | 48 |
| | C6 | 10 |

×2

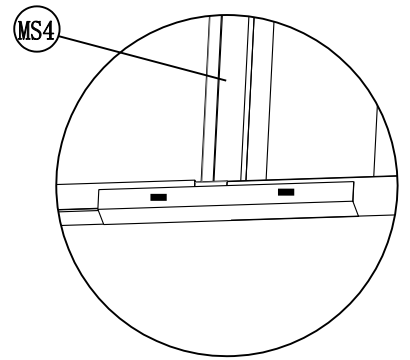
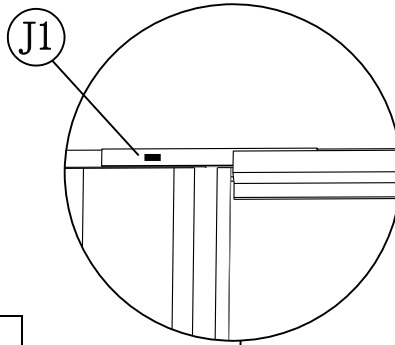
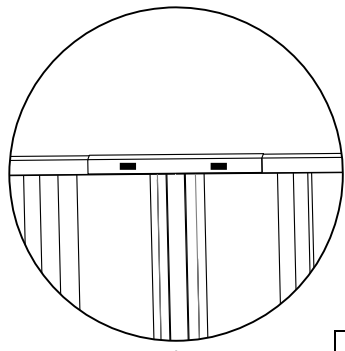
×2

ENSAMBLAJE DEL MODULAR



| | | |
|---|----|---|
|  | J1 | 3 |
|  | S3 | 2 |
|  | L3 | 2 |

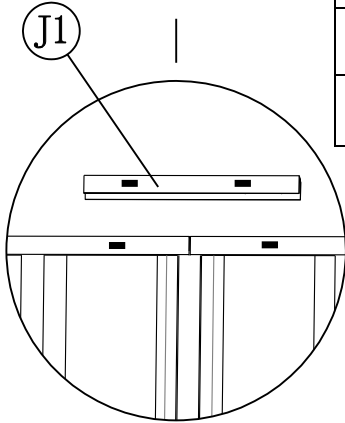

Cualquier Modulo

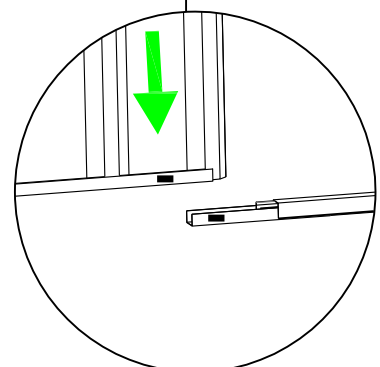
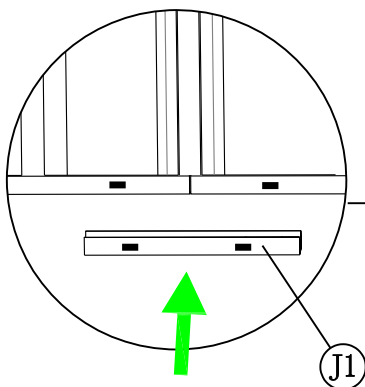
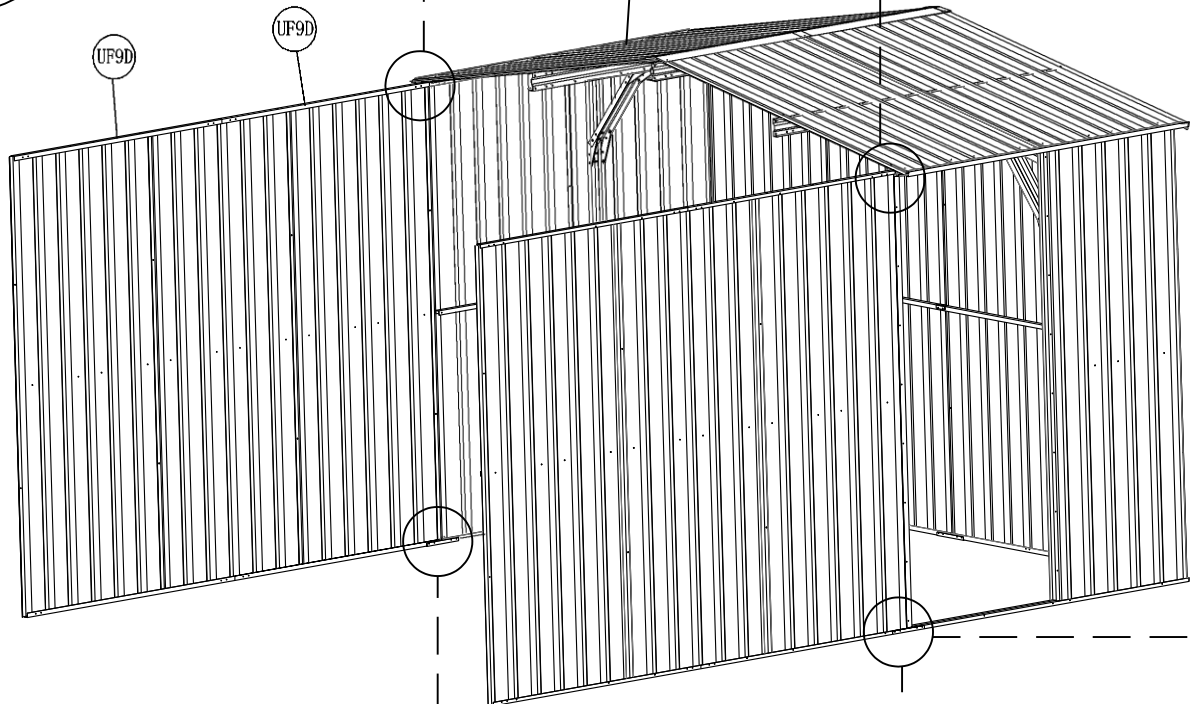

ENSAMBLAJE DEL MODULAR

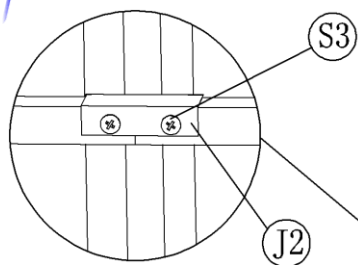

| | | | | | | |
|--|--|------|---|--|------|---|
| | | MFD4 | 1 | | J2 | 1 |
| | | S3 | 8 | | MFD2 | 1 |

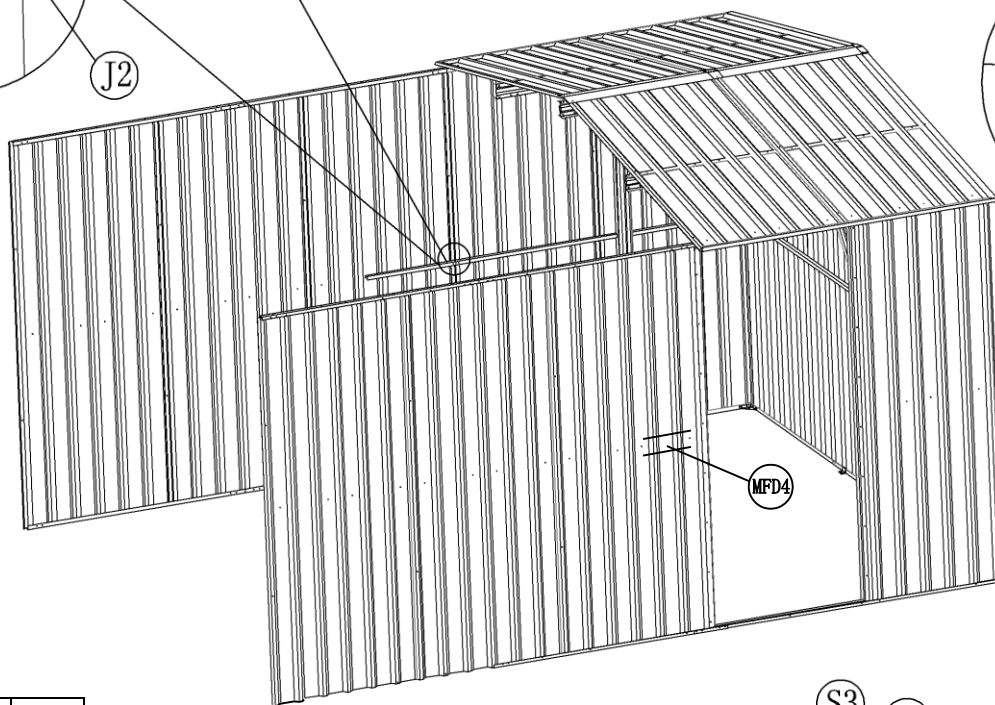
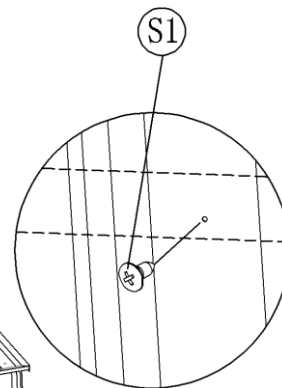

| | | | |
|--|--|------|----|
| | | MFD3 | 2 |
| | | C2 | 4 |
| | | S3 | 40 |
| | | L3 | 8 |
| | | C8 | 2 |

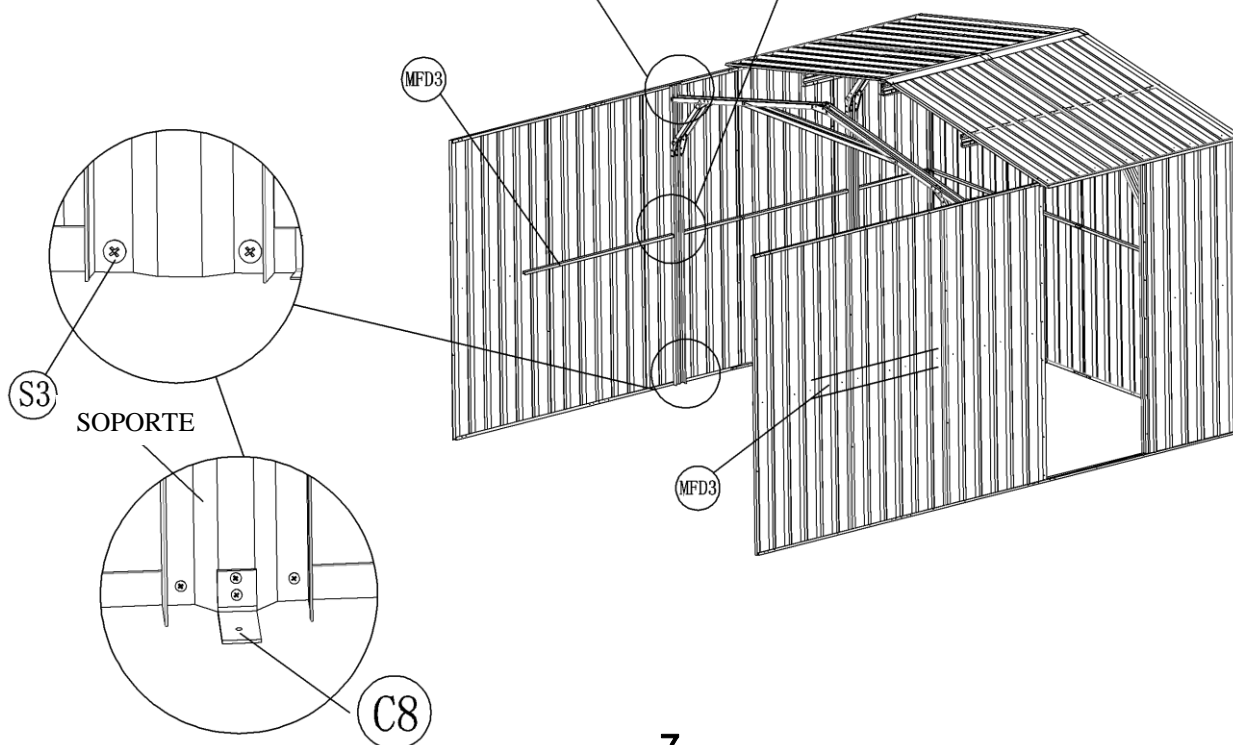
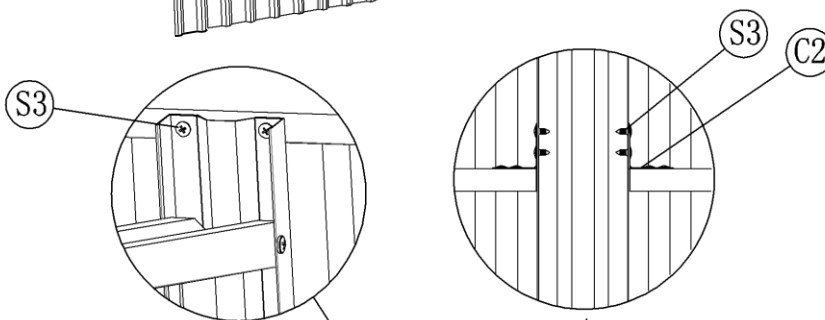

ENSAMBLAJE DEL MODULAR

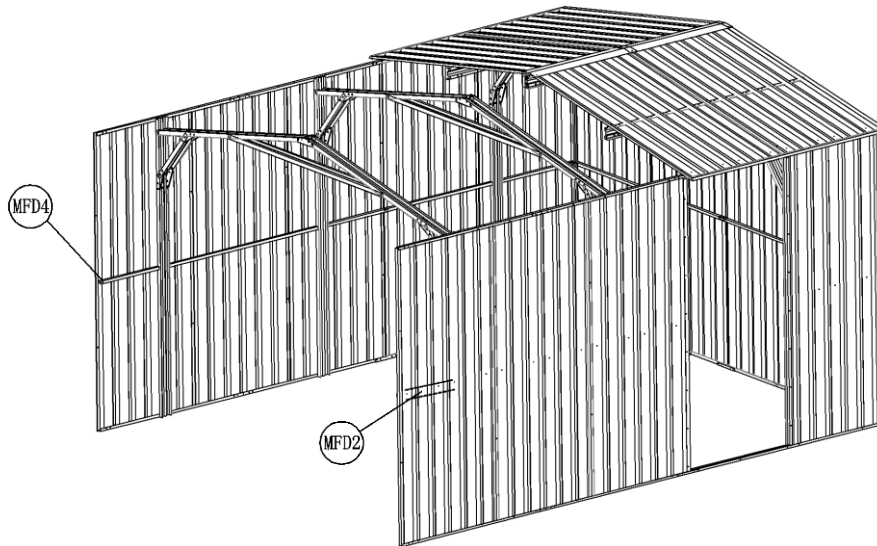

| | | |
|--|------|----|
| | MFD2 | 1 |
| | MFD4 | 1 |
| | S3 | 34 |
| | C8 | 2 |
| | C2 | 4 |
| | L3 | 8 |

| | | | | | |
|--|------|---|--|----|----|
| | UBB7 | 4 | | S8 | 12 |
|--|------|---|--|----|----|

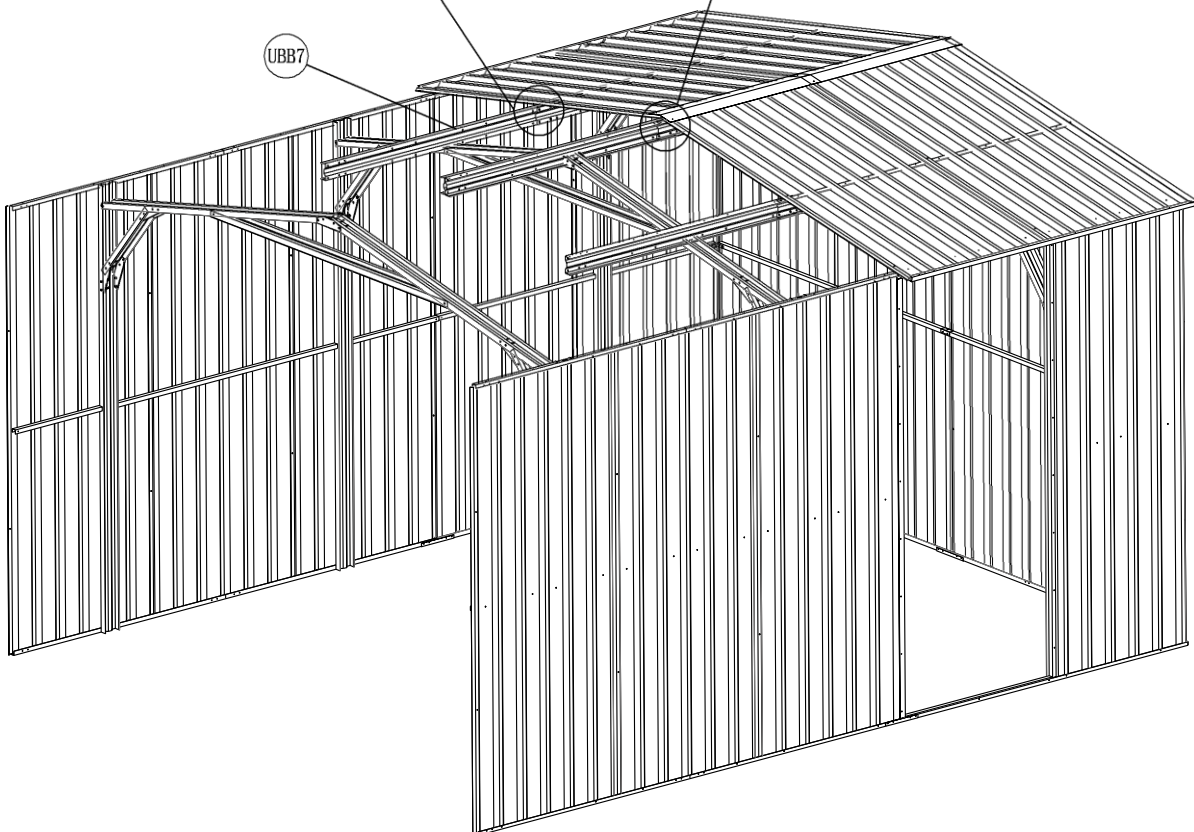
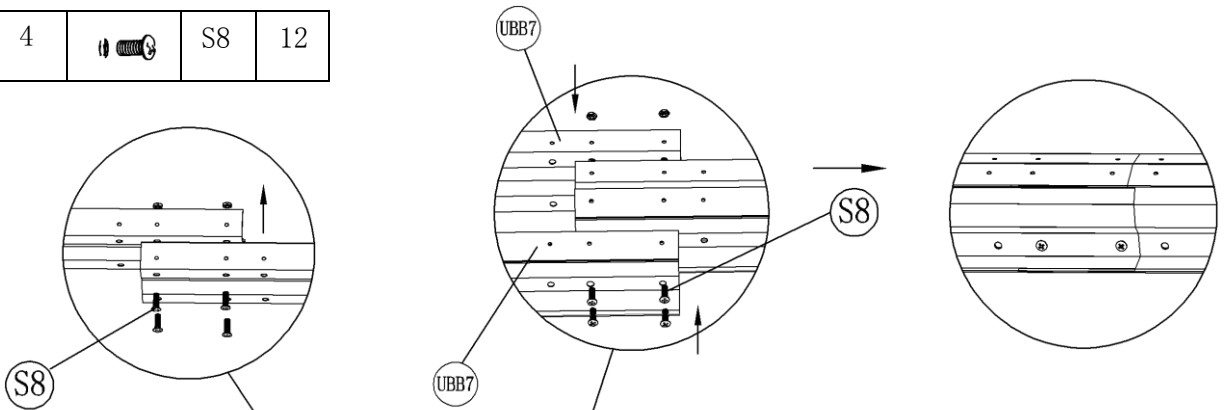

ENSAMBLAJE DEL MODULAR

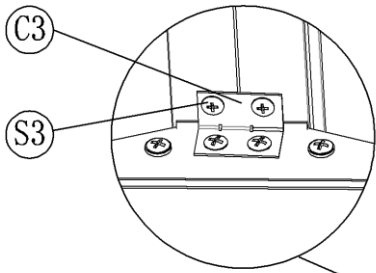

| | | | | | |
|--|------|---|--|----|----|
| | C3 | 4 | | S3 | 16 |
| | UBB7 | 4 | | S8 | 22 |

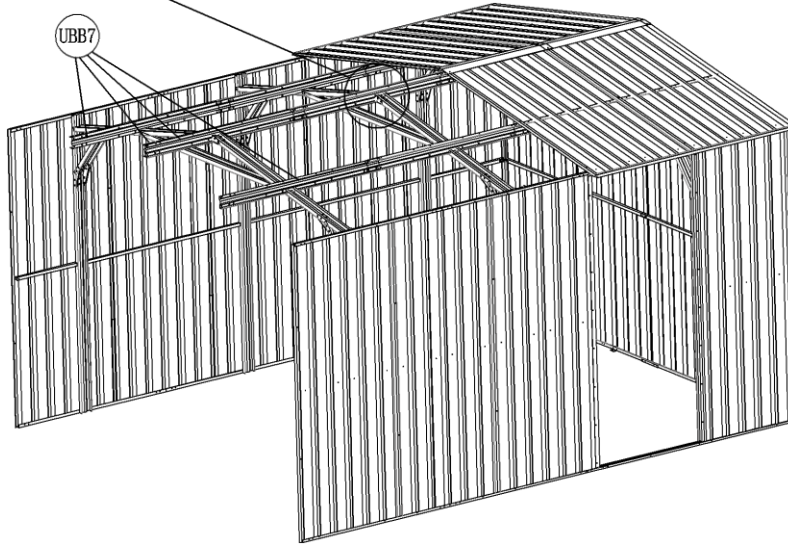

Nota. Puede decidir instalar el panel del techo al final, según las instrucciones de instalación de la casa modular frontal



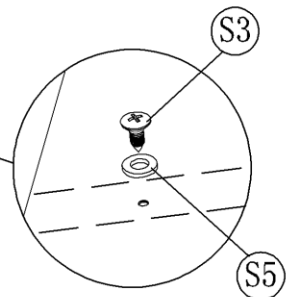
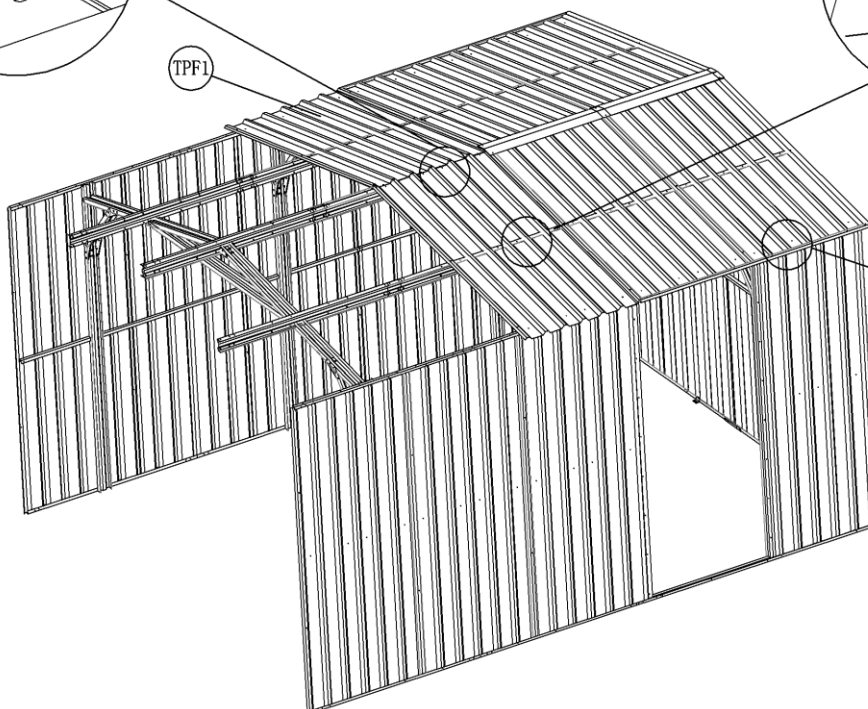
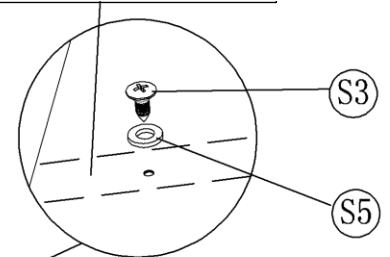
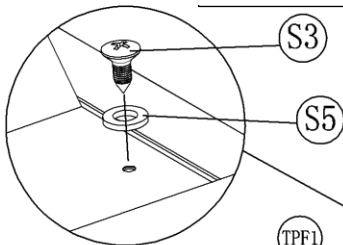

Viga Secundaria

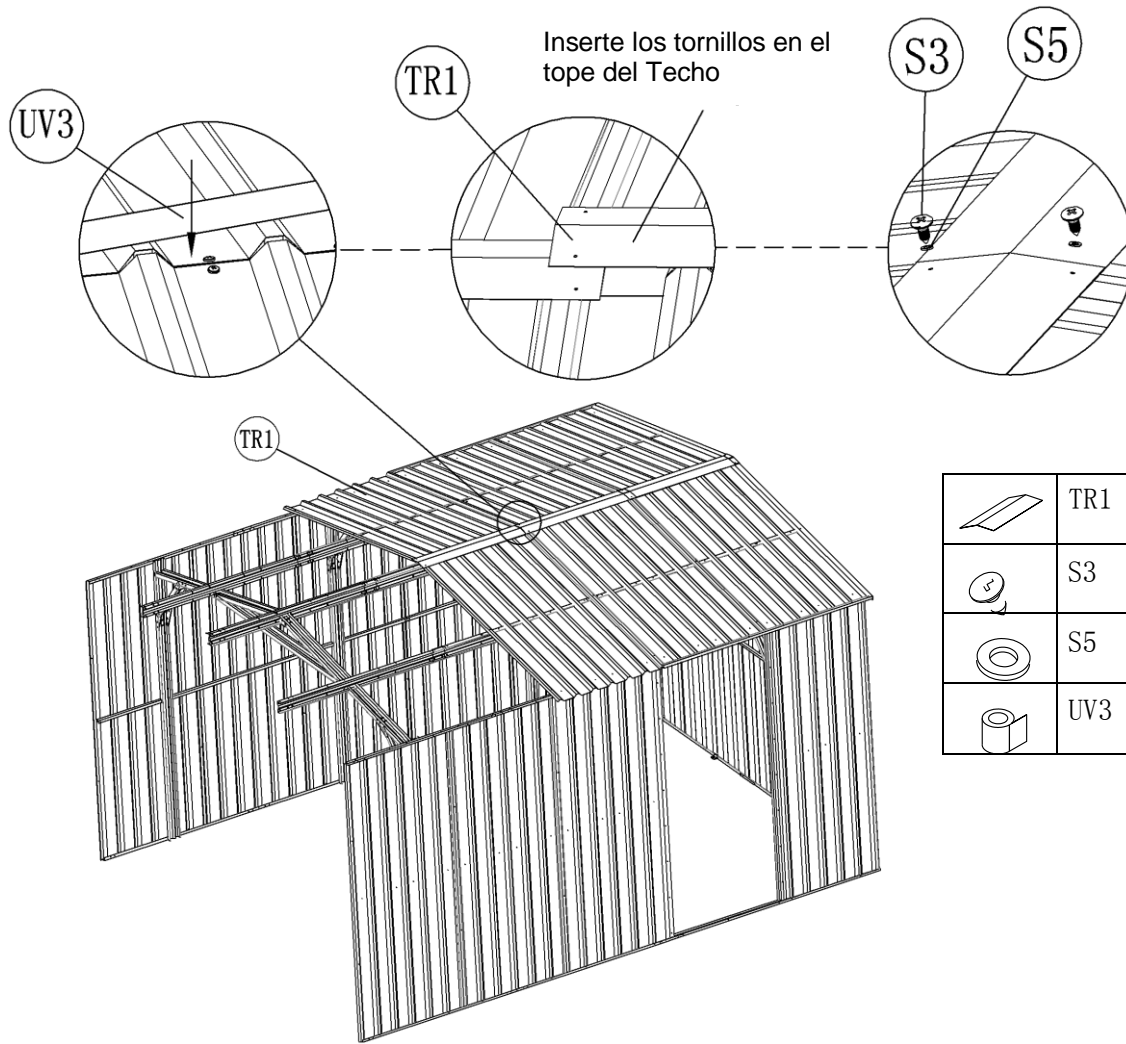

| | | |
|--|------|----|
| | TPF1 | 2 |
| | S3 | 28 |
| | S5 | 28 |



ENSAMBLAJE DEL MODULAR



| | | |
|---|-----|---|
|  | TR1 | 1 |
|  | S3 | 2 |
|  | S5 | 2 |
|  | UV3 | |

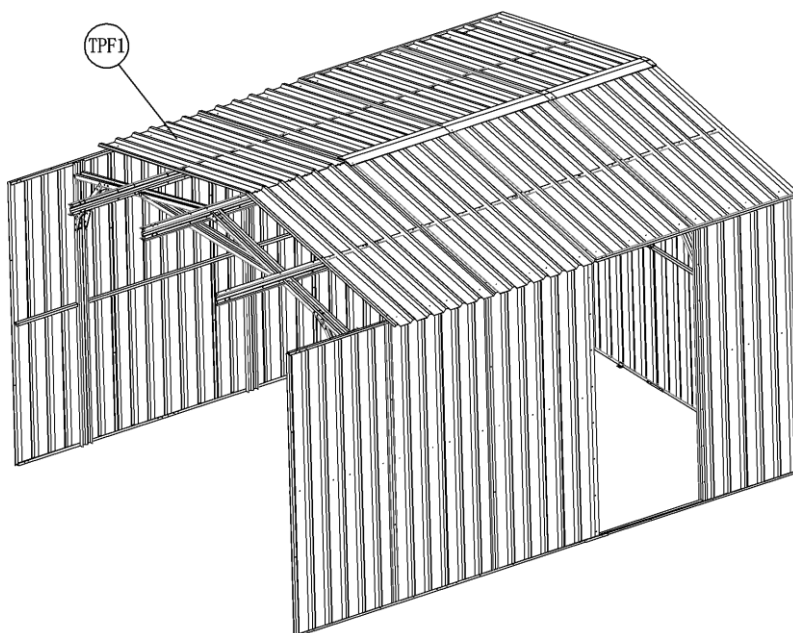

INSTALE AMBOS TPF1 Y A SU VEZ INSTALE TR1





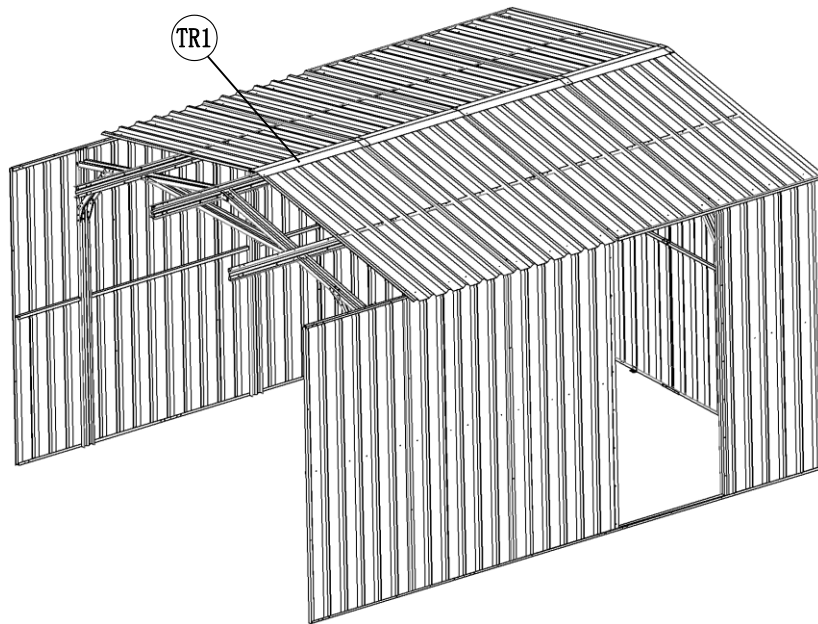

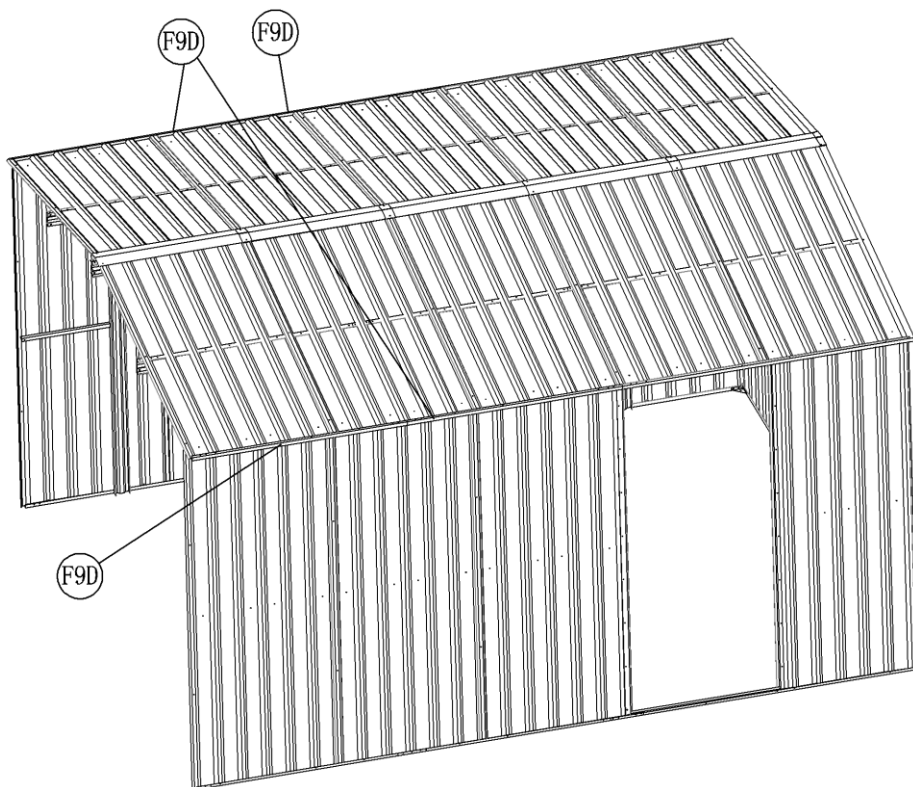

| | | |
|---|------|----|
|  | TPF1 | 2 |
|  | S3 | 28 |
|  | S5 | 28 |

ENSAMBLAJE DEL MODULAR



| | | |
|---|-----|---|
|  | TR1 | 1 |
|  | S3 | 2 |
|  | S5 | 2 |



| | | |
|---|------|----|
|  | TPF1 | 2 |
|  | TR1 | 1 |
|  | S3 | 30 |
|  | S5 | 30 |
|  | F9D | 4 |
|  | J1 | 4 |