

INSTRUCCIONES DE INSTALACION

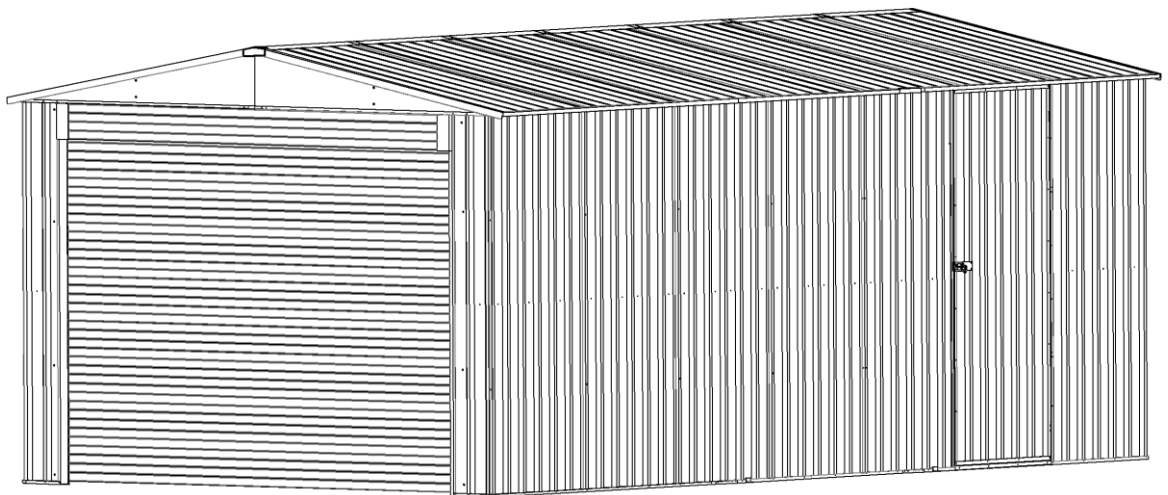





Bosen Industrial. www.bosen.cl

-- Puerta Persiana Manual

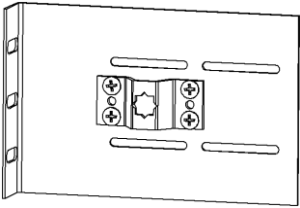
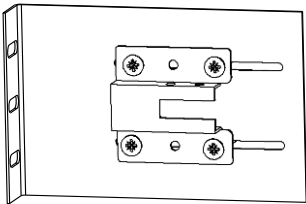

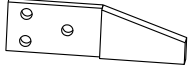
Ensamblaje Puerta Persiana

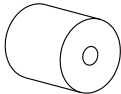
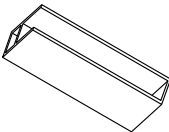
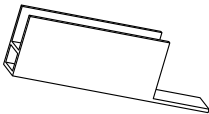
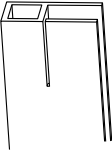
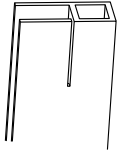
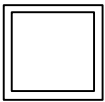
EL ENSAMBLADO DE LA PUERTA PUEDE REQUERIR LAS SIGUIENTES PARTES

				
A	S	C	M	
				
N	O	P	Q	R
				
GR1	GR2	MSL1	S12	S13

Ensamblaje Puerta Persiana Manual

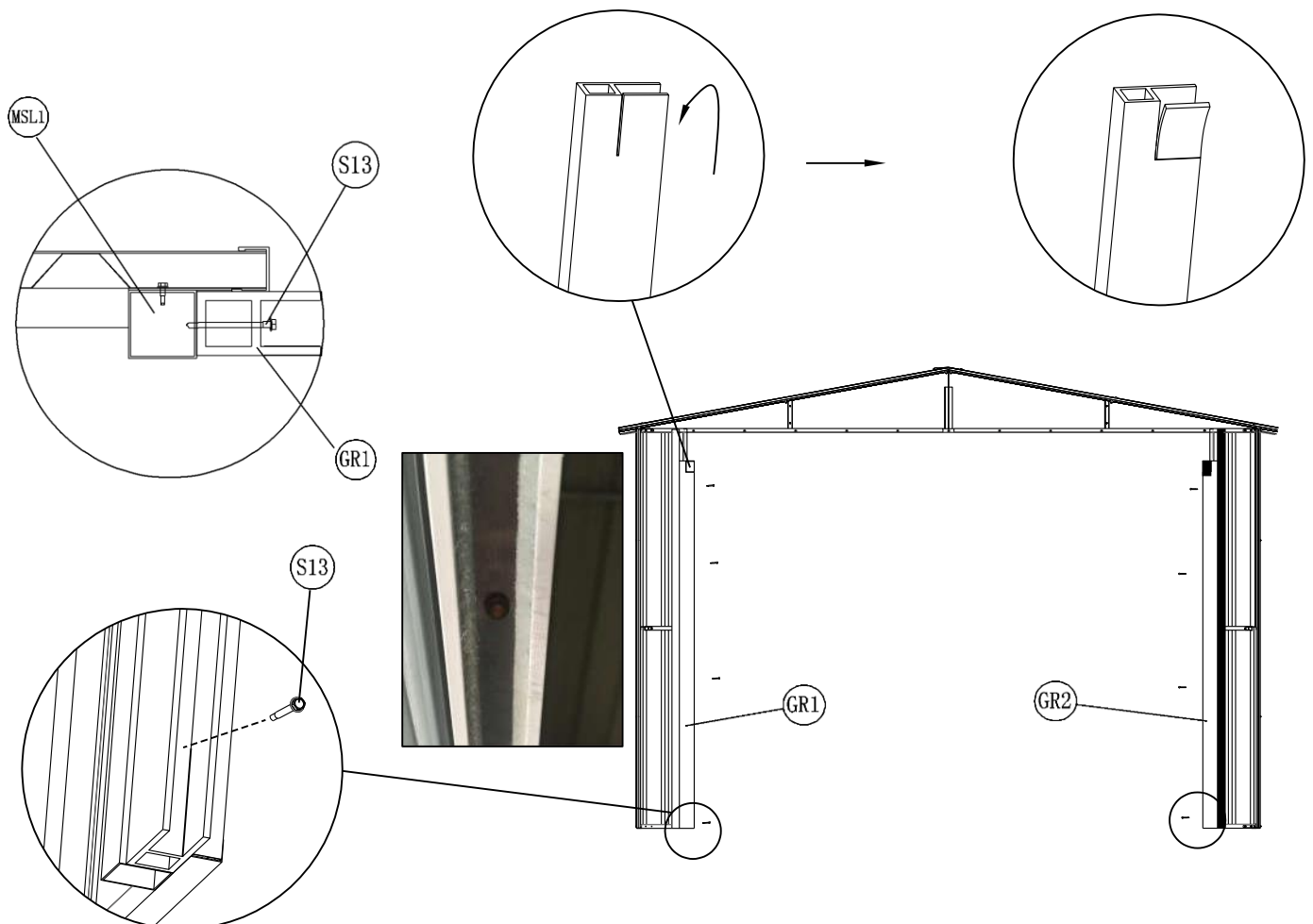
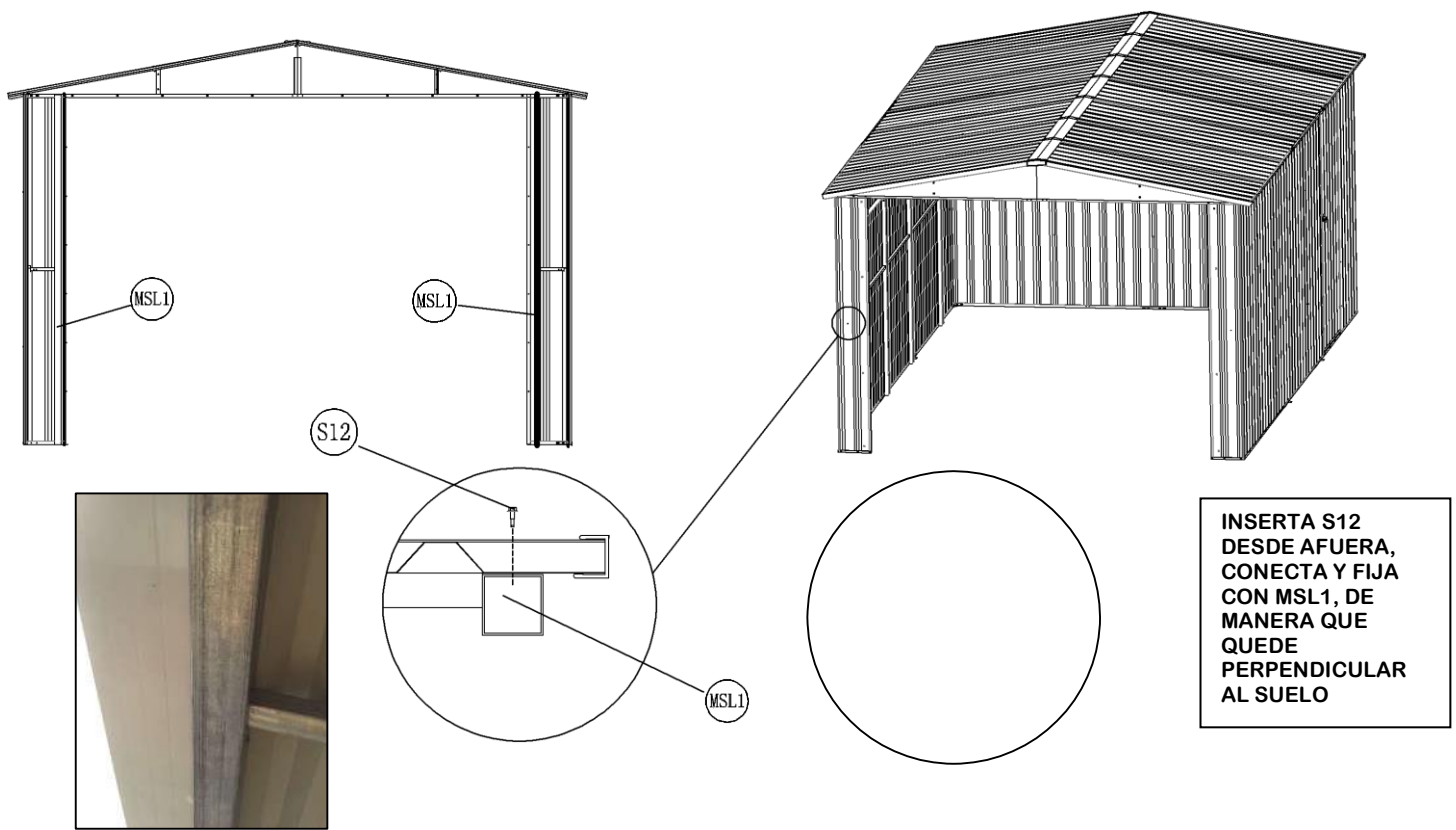

Ensamblaje de Puerta Persiana Manual

ASEGURESE QUE LOS CENTROS DE A Y S ESTEN EN LA MISMA POSICION HORIZONTAL

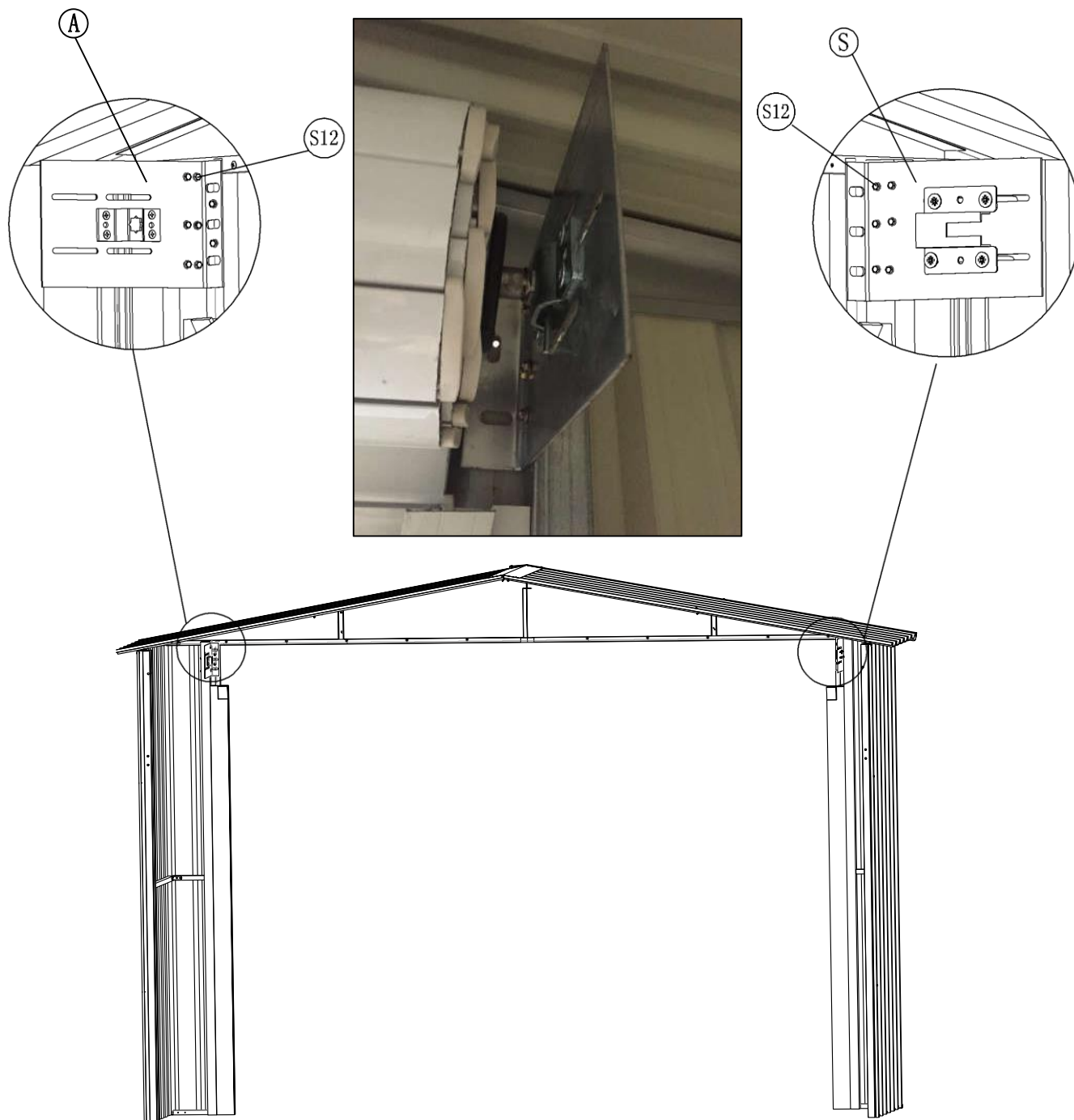

Ensamblaje de Puerta Persiana Manual

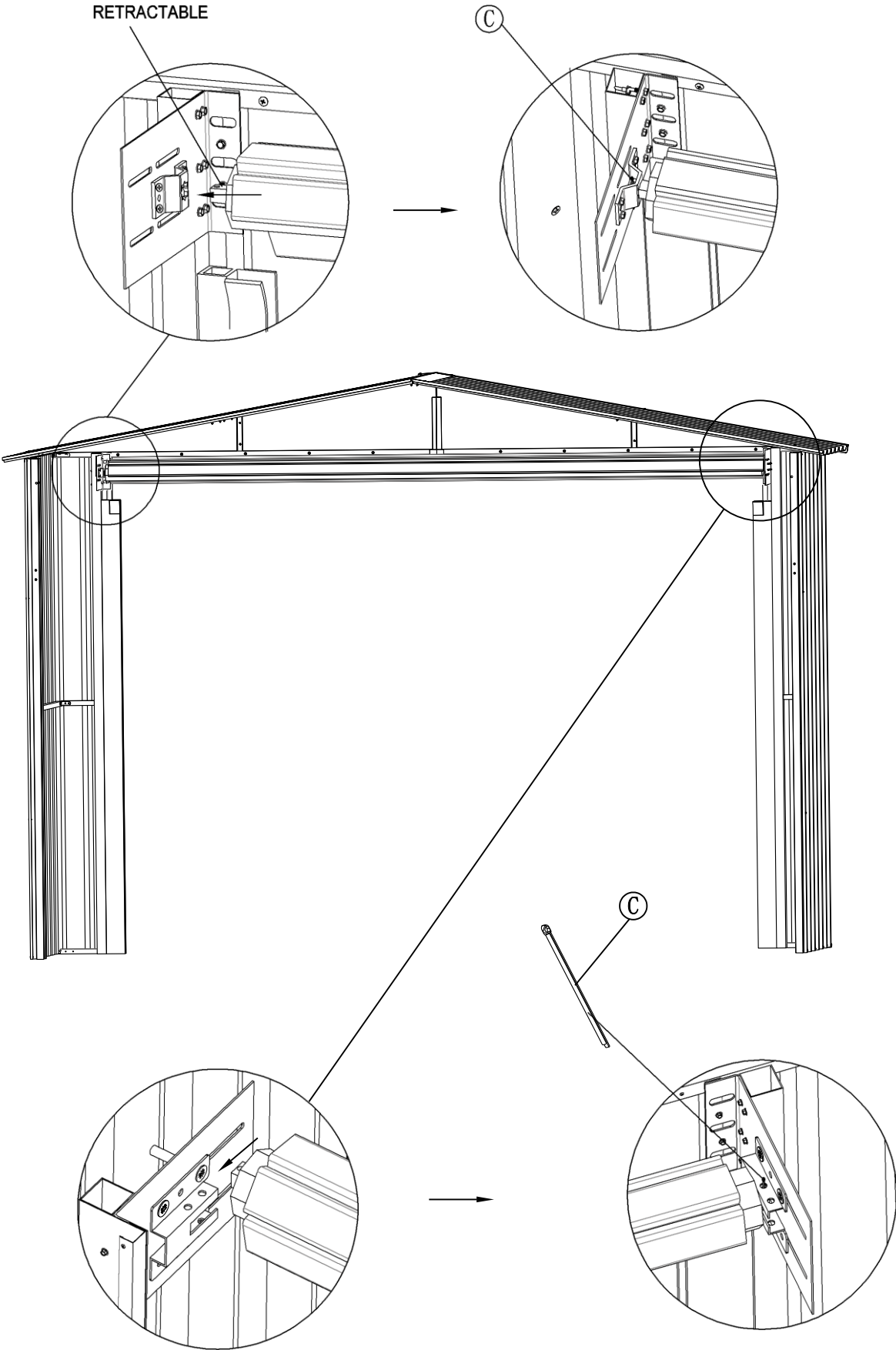

Ensamblaje de Puerta Persiana Manual

Sujetar la puerta antes de rotarla.

Realice dos vueltas en dirección de la flecha, si la sujeción es moderada, inserte la puerta dentro del riel guía. Hale la puerta suavemente con las manos hacia la parte superior de la puerta, y asegúrese que la tensión sea la apropiada, si piensa que no es adecuada, separe el riel guía, e incremente o disminuya el torque nuevamente. Repetir el procedimiento hasta que la puerta deslice suavemente.

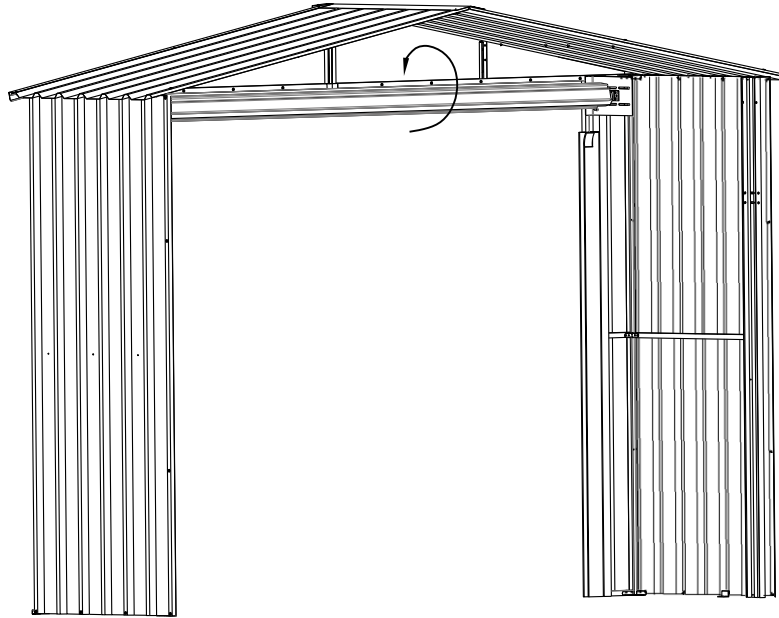

Incrementar el torque

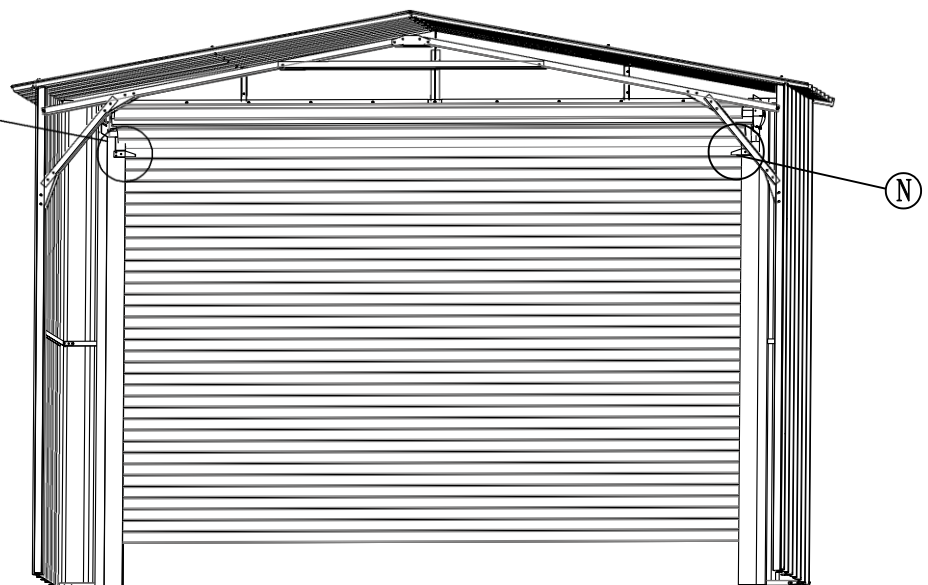
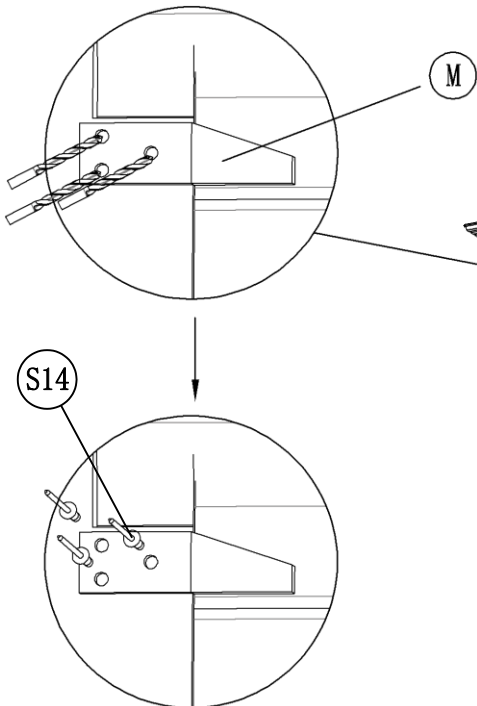
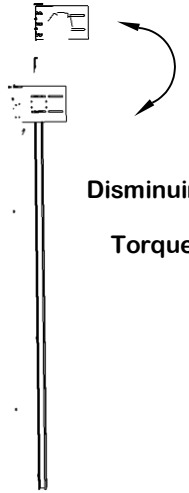

Ensamblaje de Puerta Persiana Manual

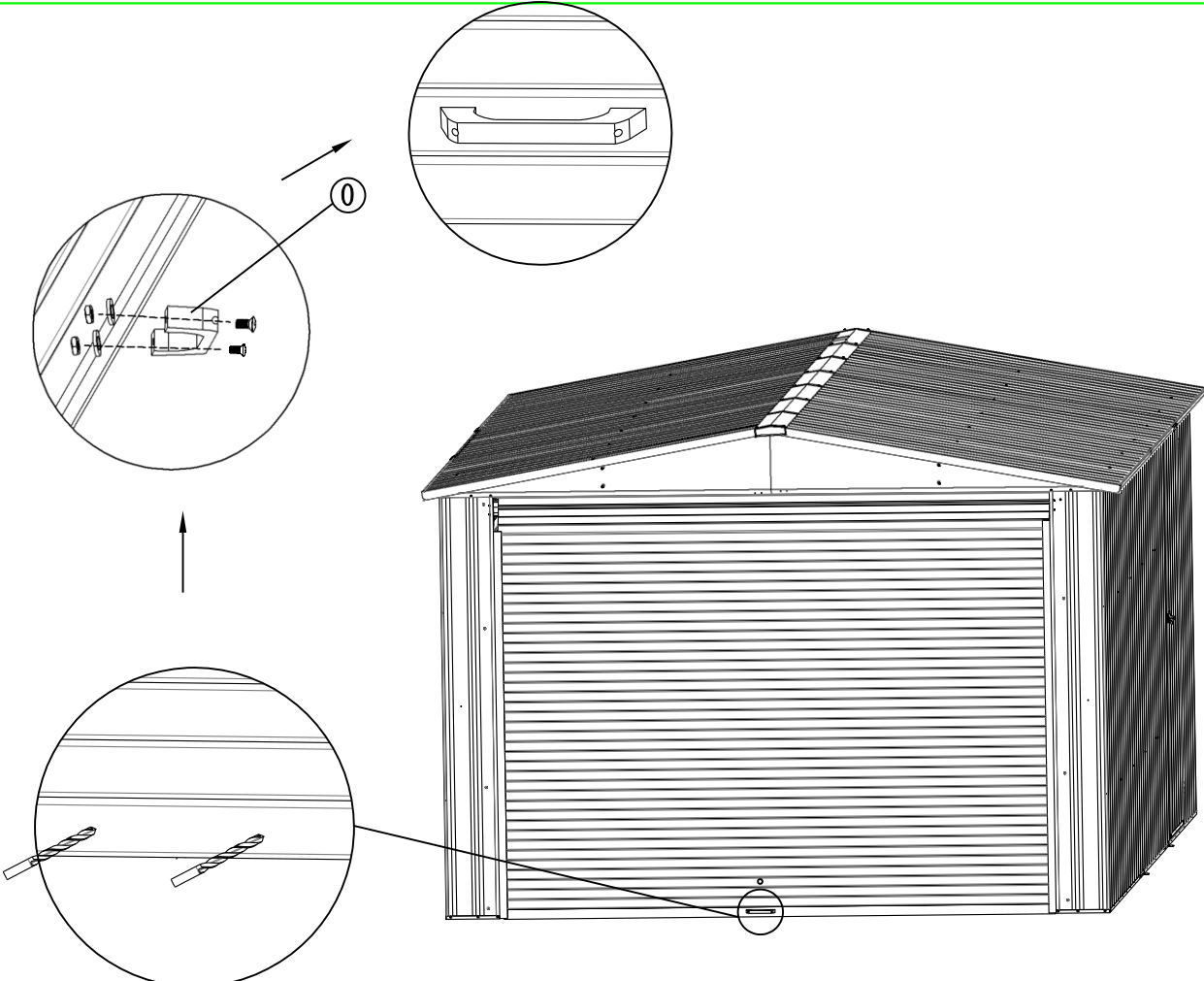
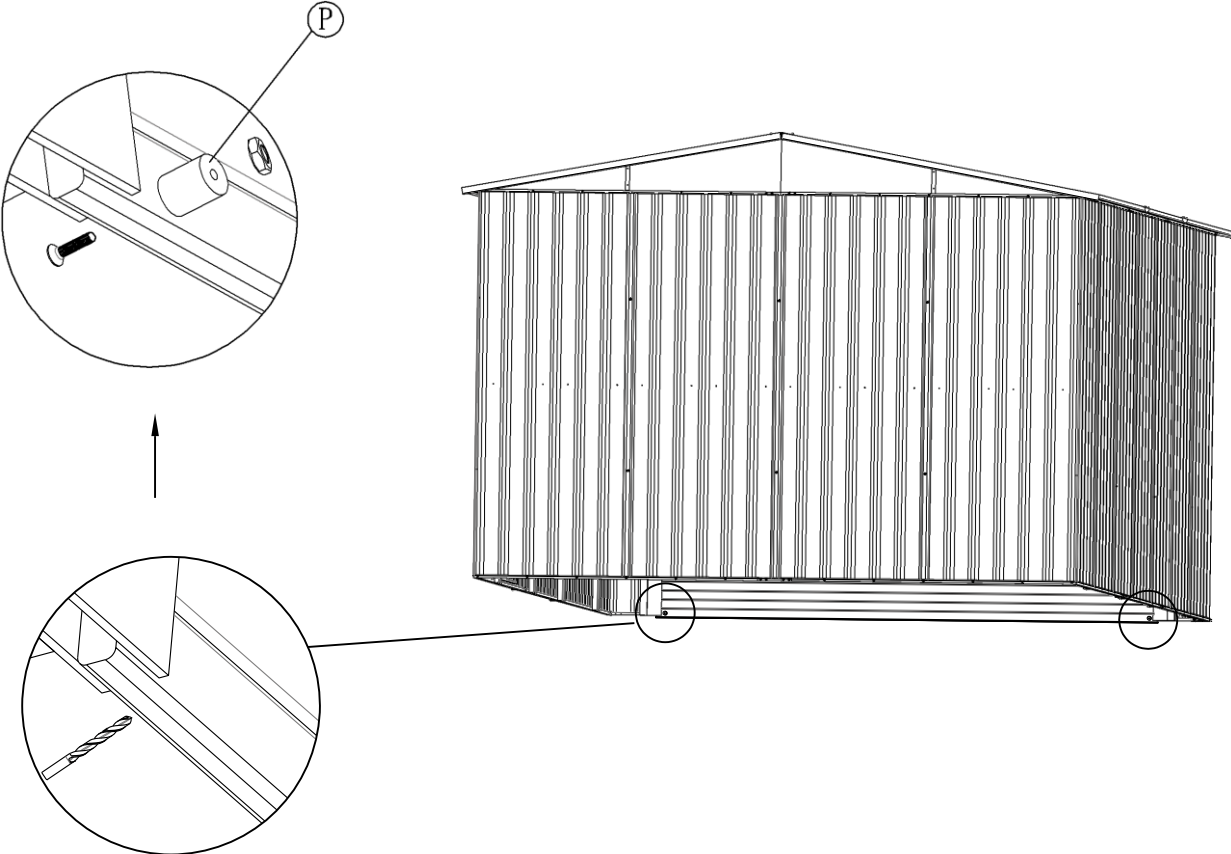

Ensamblaje de Puerta Rotatoria Manual

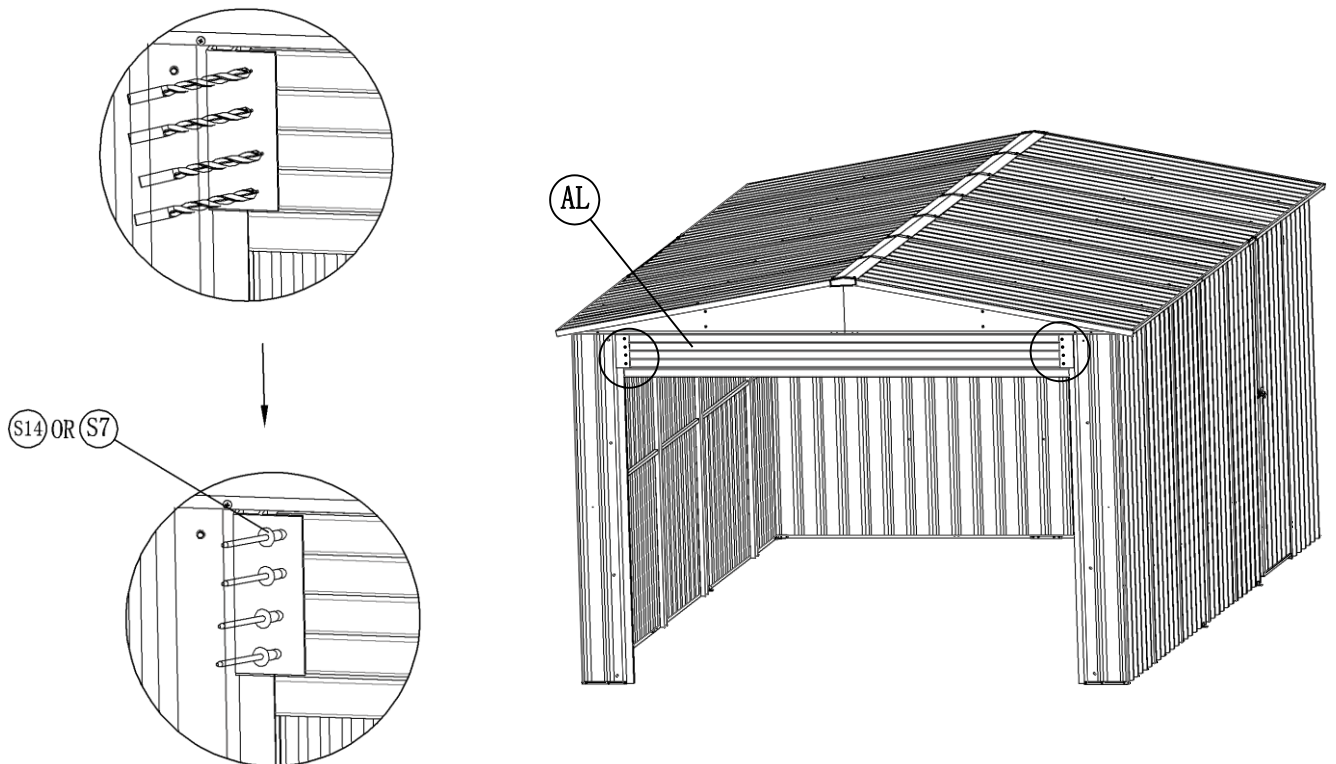
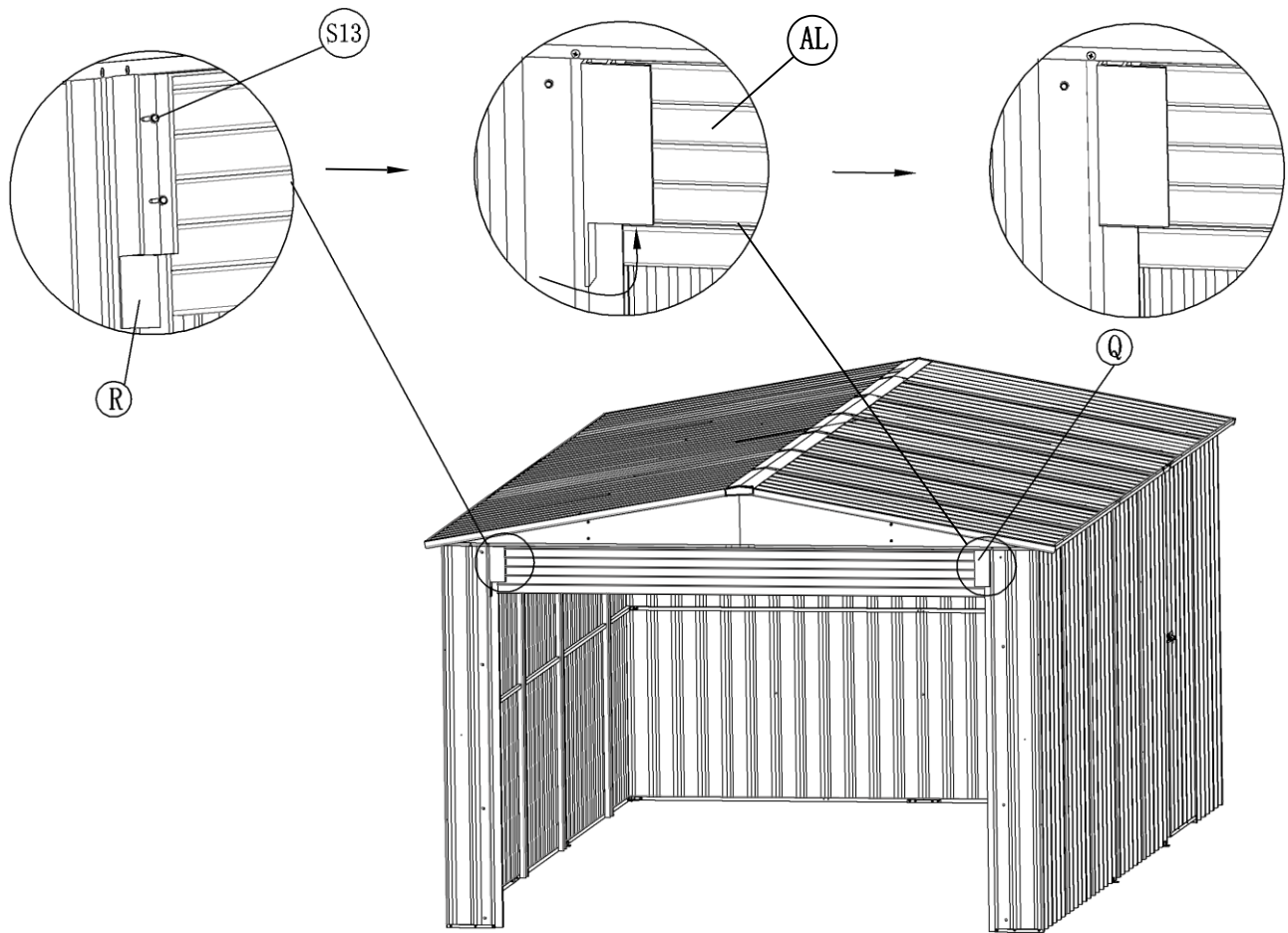

GRACIAS POR ELEGIR NUESTROS PRODUCTOS